

Minimal self-replicating systems

Andrew Robertson, Andrew J. Sinclair and Douglas Philp*

School of Chemistry, University of Birmingham, Edgbaston, Birmingham, UK B15 2TT

Received 24th November 1999

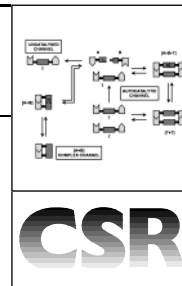

Examples of chemical systems capable of templating and catalysing their own synthesis—self-replicating systems—have begun to appear in the chemical literature over the last 15 years. For the biologist, these systems represent a link with the origin of life—their study can shed light on prebiotic chemical evolution. However, for the synthetic chemist, they represent the ultimate synthetic machine, capable of templating the production of a large number of perfect copies of themselves from a single original molecule. In this Review, we describe the design and synthesis of synthetic minimal replicating systems and provide a general overview and critique of the field.

1 Why study molecular self-replicating systems?

Geological history leaves us with an enormous knowledge gap regarding the events which occurred between the emergence of a benign, yet sterile, Earth and the time at which the first organisms¹ lived and died. Their fossils provide us with a very rough estimate of when the first living entities² inhabited this planet. Uncovering the chain of events which led to the emergence of the first living organisms involves many scientific

disciplines, but the general consensus is clear—in order to spontaneously generate a living entity from a chemical mixture (and the origin of this mixture itself provides scope for much speculation), at some point molecular systems that were capable of passing structural, proto-genetic information on to other molecules, in order to replicate³ themselves, must have developed.

Without any real clue as to the nature of these original systems and properties, chemists must create model systems (so-called artificial self-replicating systems) that demonstrate⁴ the required principles. However, the additional benefits of molecules which can transmit and amplify structural information are of significant utility in both chemistry and biology. In the field of prebiotic chemistry, these systems serve as models for processes implicated in the origin of life and, hence, their study could shed light on prebiotic chemical evolution.⁵ For the synthetic chemist, they have the potential to operate⁶ as the ultimate synthetic machines, capable of templating the formation of a large number of perfect copies of themselves from a single original molecule. Therefore, the case for studying these complex and intriguing systems is quite clear. Indeed, research in this area has produced numerous systems of sometimes bewildering complexity. The account which follows is designed to provide an overview and a critique of the key studies

Douglas Philp was born in Glasgow, Scotland on the last day of 1967. After attending school in the West of Scotland, he moved to Aberdeen in 1985 to study Chemistry at the University of Aberdeen, where he gained his BSc degree in 1989. Subsequently, he undertook studies toward his PhD in the laboratories of Professor Fraser Stoddart, firstly at the University of Sheffield and then at the University of Birmingham—completing a thesis entitled ‘Self-Assembly in Chemical Systems’ in 1992. After a period as a Royal Society European Science Exchange Programme Postdoctoral Fellow at the ETH, Zürich in the laboratories of Professor François Diederich, he returned to the University of Birmingham in 1994 to take up an academic position. He was appointed to his current position of Senior Lecturer in Physical Organic Chemistry in October 1997. His current research interests focus on the development

of self-assembling and self-replicating structures and the application of computational methods to problem-solving in chemistry.

Andrew Robertson was born in 1971 in Bath, England. In 1990 he went to the University of Manchester Institute of Science and Technology where he obtained a BSc (Hons) in Chemistry with Computer-Aided Chemistry. After working for a year in the commercial sector he returned to chemistry in 1994 to study for a PhD with Dr Douglas Philp at the University of Birmingham. He is currently undertaking research as a Japan Society for the Promotion of Science Postdoctoral Fellow with Professor Seiji Shinkai at the University of Kyushu, Japan.

Andrew J. Sinclair was born in 1974 in Ipswich, England. After leaving school in 1993, he gained a year of process development experience with Rhône-Poulenc, before taking a place to study Chemistry at the University of Birmingham. He obtained his BSc (Hons) in 1997 and joined the research group of Dr Douglas Philp. He is currently studying for a PhD, undertaking research in the area of recognition-mediated control of chemical reactivity.



Douglas Philp



Andrew Robertson

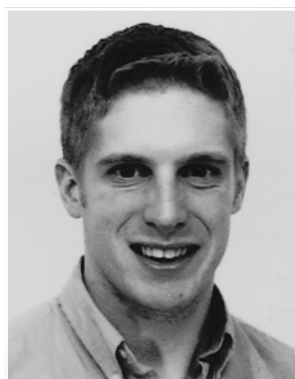

Andrew J. Sinclair

performed to date in this area. In limiting the number of papers covered, it is hoped to clarify the confusing aspects associated with such systems and allow clearer understanding of the mechanism and design of self-replicating molecules.

2 Definitions

Any account of the field of self-replicating systems must first draw a distinction between self-replication and simple autocatalysis. A distinction between these two forms of related reactivity is by no means clear, but is important nevertheless. In an autocatalytic reaction, the product of the reaction is itself a catalyst for that reaction. The autocatalytic cycle returns more catalyst to the reaction each time the cycle is completed and the rate of the reaction accelerates until the starting materials necessary for reaction begin to run out. The dwindling supply of precursors then becomes a limiting factor and the reaction rate decreases. This behaviour gives the time course of an autocatalytic reaction its characteristic sigmoidal shape (Fig. 1) which is a feature of the exponential growth of the product and decay of the starting materials.

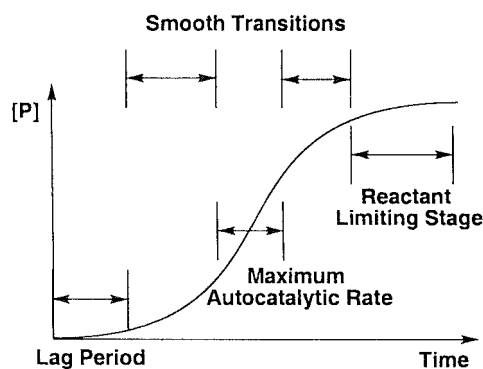

Fig. 1 The characteristic sigmoidal time course of an autocatalytic reaction. [P] represents the concentration of product.

An essential aspect of the autocatalytic cycle is the return of catalyst to the reaction mixture. A reaction that does not return some catalyst to the reaction mixture is not autocatalytic, regardless of the nature of any associated catalyst. An example of autocatalysis is the acid-catalysed bromination of propan-2-one. In this reaction, the HBr which is formed, in addition to the 1-bromopropan-2-one, is capable of catalysing the bromination reaction. The important characteristic of this form of autocatalysis is the total lack of specificity of the catalyst. The reaction is catalysed by any Brønsted acid and the HBr produced by the reaction will react with any Brønsted base.

Whilst self-replicating systems form a subset of autocatalytic reactions, their key distinguishing feature is that a molecule which is capable of self-replication will only catalyse its own formation. Self-replicating molecules, whether being studied with reference to the origins of life or with a view to other applications, are designed as selfish catalysts. A simple autocatalytic system cannot amplify 'information' effectively, whether that information is composed of a base pair sequence or stereochemistry within a molecular structure, if it simultaneously amplifies 'noise' in the form of unwanted side products. A self-replicating molecule, with its specific catalysis, should be able to minimise or, ideally, eradicate losses to other reaction products. This specificity is not a simple feature to design into a reaction system and the simplest model available for a selfish autocatalytic cycle is the minimal self-replicating cycle (Fig. 2). Three possible reaction channels exist. The first is the uncatalysed bimolecular reaction of self-complementary building blocks **A** and **B** to produce the replicating template **T**. The second pathway is the autocatalytic cycle. **A** and **B** simultaneously bind to **T** to form the ternary complex $[A \cdot B \cdot T]$. The

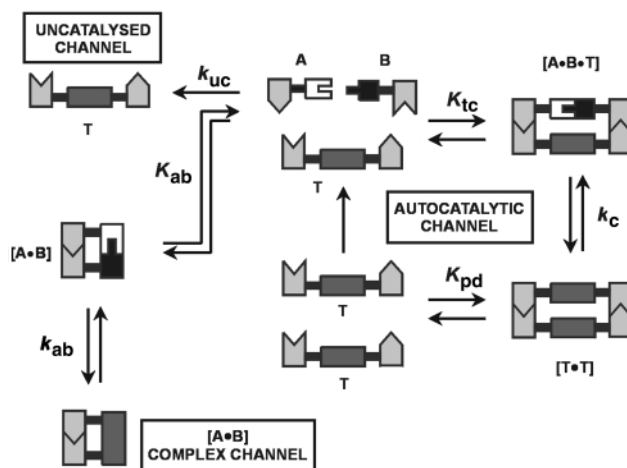

Fig. 2 Minimal model for the replication of a template **T** through an autocatalytic cycle.

selectivity of the template arises from the specific molecular interactions required to assemble the building blocks in the correct orientation to facilitate the bond forming step. The apparent higher concentration of the building blocks assembled on the template increases the rate of reaction and is responsible for the catalytic nature of the template. Bond formation is facilitated between **A** and **B**, forming a copy of **T** within the product duplex $[T \cdot T]$.

The autocatalytic function of the self-replicating template is only completed, however, when the product duplex produced by the termolecular complex dissociates to return two free catalytic templates to the reaction mixture. Exponential growth should then arise as two templates make four, four make eight and so on. The importance of the autocatalytic cycle to the overall reaction rate depends on the magnitude of K_{tc} , K_{pd} and k_c compared with K_{ab} , k_{ab} and k_{uc} .

In addition to template production *via* the termolecular complex and bimolecular reaction, another competing reaction must be considered. **A** and **B** possess the ability to associate with each other as a consequence of the complementary nature of their recognition sites. This association leads to the reversible formation of an $[A \cdot B]$ complex. If the reactive sites are orientated correctly with respect to each other, reaction between the two building blocks may proceed at an accelerated rate *via* this recognition. The behaviour of a reactive complex must be taken into account when designing a replicating system as the formation of such binary complexes is inevitable. The reactive AB complex⁷ has the potential to quench the autocatalytic cycle. Formation of an AB complex requires only one association between two components, as opposed to two associations between three components required to create the $[A \cdot B \cdot T]$ ternary complex. This difference results in much higher concentrations of the AB complex being present in solution when compared to that of the ternary complex for the greater part of the time course of the reaction. The product from a reactive binary complex may retain the association properties from the initial recognition event, promoting a product with intramolecular association between complementary recognition sites and, thus, further reducing the quantity of template returned to the catalytic cycle. Careful consideration and manipulation of molecular structure can eradicate this reaction channel.

The key problem in the autocatalytic cycle, as far as minimal self-replicating molecules are concerned, is that the product duplex $[T \cdot T]$ should be intrinsically more stable than the ternary complex $[A \cdot B \cdot T]$. This behaviour raises the possibility of a nominally self-replicating molecule that cannot complete the autocatalytic cycle, since the product duplex cannot dissociate and, hence, prevents autocatalytic turnover. Such a system may be termed self-replicating because it constructs one

complex, was not reported, though presumably this association was present. Although a sigmoidal curve was not observed for this reaction system, von Kiedrowski went on to demonstrate autocatalysis by showing that adding small amounts of template to the reaction mixture increased the *initial* rate of the reaction. Overall, the addition of template had a much smaller effect on the production of **4**, actually causing a slight inhibition, presumably as a result of both systems competing for activated free ester **1**. von Kiedrowski postulated that the kinetics of this system are described best when the production of template dimer, not free template, is considered (leading to the formulation⁹ of the 'square root law'). This observation gives an indication of the high level of product inhibition present. Although the reaction was classified as autocatalytic, it was not returning significant quantities of template to the reaction mixture. Therefore, a better interpretation would be that the sequence is replicated, but the system displays limited autocatalysis.

von Kiedrowski and coworkers provided further evidence for their template-directed mechanism by demonstrating¹⁰ the degree of catalysis was sequence dependent. This was achieved by employing a number of trinucleotide building blocks designed to provide varying degrees of base sequence mismatches with respect to the original building blocks. The original sequence was also extended¹¹ to exploit a faster ligation reaction. In this case, the original base sequence was conserved and the hydroxy functional group was replaced by an amine. The resulting coupling of the building blocks *via* the phosphoramidate linkage was catalysed by 1-(3-dimethylaminopropyl)-3-ethylcarbodiimide hydrochloride. The essential feature of this

work is that von Kiedrowski and coworkers were able to demonstrate, for the first time, a sigmoidal time course for the production of template. This change in behaviour was attributed to the faster covalent linking step enhancing the difference between the template-directed reaction and the bimolecular reaction. Again, the kinetics were best described when considering the turnover of the template duplex, pointing to a stable product duplex inhibiting the catalytic cycle. The fact that this system experiences strong inhibition and still succeeds in contributing enough free template to generate a sigmoidal concentration–time profile is indicative of powerful template-directed catalysis.

After demonstrating template-directed catalysis through the minimal model, von Kiedrowski and coworkers turned to more ambitious projects, linking their studies to conditions¹² for prebiotic self-replicating systems and, most recently, designing¹³ an intricate cross-catalytic system. A cross-catalytic self-replicating system (Fig. 4) involves the use of complementary templates instead of self-complementary templates. The template **AA'** assembles the building blocks for template **B'B** and *vice versa*, theoretically leading to a hybrid autocatalytic cycle.

The design of a cross-catalytic system necessitates the simultaneous presence of two competing self-replicating systems and a second cross-catalytic system, unless different recognition and reactive sites are used between the cross-catalytic templates. Fortunately, the competing cross-catalytic system is not possible in the system described by von Kiedrowski, a result of the directional sequence dependence of nucleotide recognition. The system reported again utilises

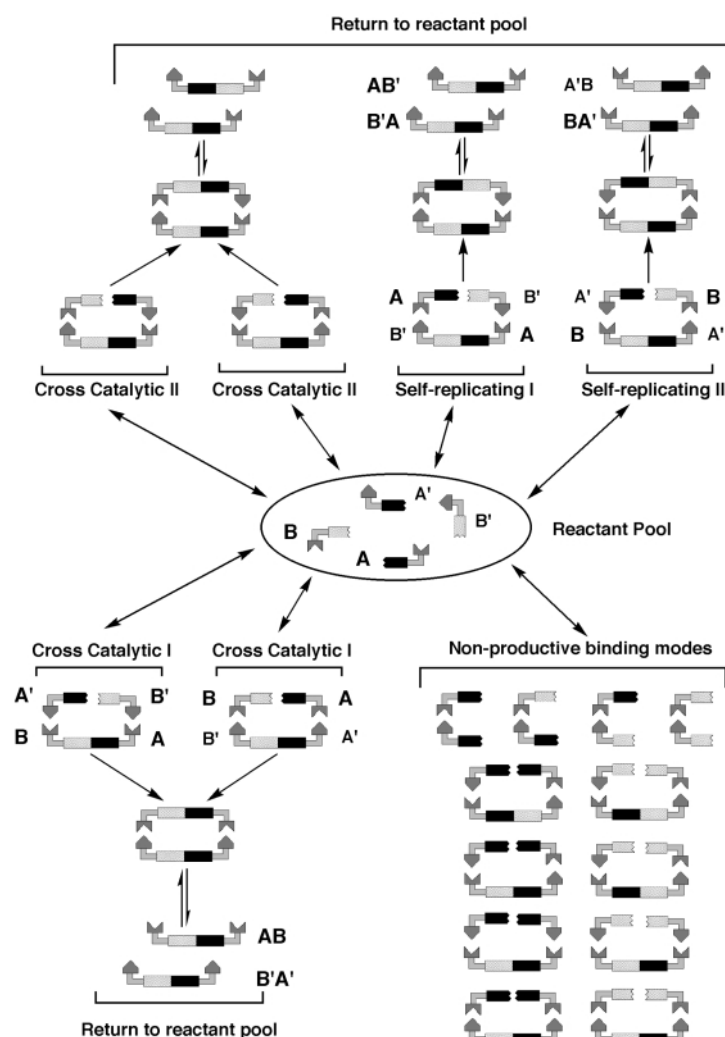

Fig. 4 A minimal cross-catalytic system, created from building blocks **A**, **A'**, **B** and **B'**. The competing cross-catalytic system II is not possible in von Kiedrowski's cross-catalytic system.

cytosine- and guanine-based oligonucleotides, accepting the high degree of product inhibition inherent with the use of this recognition motif. The productive termolecular complexes are detailed in Fig. 5. The results obtained indicate that, in the

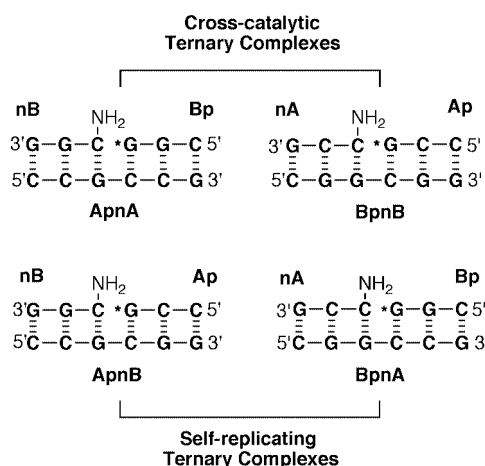

Fig. 5 The productive nucleotide termolecular complexes in von Kiedrowski's cross-catalytic system, where '*' represents activated ester.

absence of seeding with a prefabricated template, the initial rates of production of the four templates (ApnA, BpnB, ApnB and BpnA) are identical. When seeded with a presynthesised *complementary* template (*i.e.* ApnA or BpnB), the initial rate of production of the corresponding *complementary* template (*i.e.* BpnB or ApnA respectively) is accelerated. Additionally, the competing production of the *self-complementary* templates ApnB and BpnA in these reaction mixtures is effectively suppressed. This implies that the complementary templates provide the most effective competition for the supply of building blocks and starve the self-complementary templates of starting materials. Consideration of the cross-catalytic cycle leads to the realisation that the production of *both* complementary templates should be enhanced on seeding with *one* of ApnA or BpnB. The observation that only production of the corresponding template is enhanced confirms the high stability of the product duplex, preventing return of free templates to the reaction mixture. The self-complementary templates prove to be less efficient catalysts on seeding, achieving a less pronounced increase in initial rate.

von Kiedrowski and coworkers have produced an extensive array of elegant and ingenious systems based around the minimal model and have significantly contributed to advancements in our knowledge and understanding of this field. However, their kinetic analysis is firmly based around the initial stages of a reaction, a situation enforced by the high intermolecular association found in the template duplex and the low completion through to products. Consequently, the degree of turnover is much lower than would be expected for an ideal self-replicating system.

A radically different approach¹⁴ was pursued by Li and Nicolaou, who reasoned that a weaker nucleotide interaction would prevent product inhibition. Instead of designing a product based upon the strong Watson–Crick binding interactions of double strand DNA, a strategy employing the weaker interactions arising from Hoogsteen-type binding within a triple helix was implemented. Replication of the structural information contained in a double helix was achieved, but required careful manipulation of building block concentration and pH to enable completion of the cycle. This inefficient process required all the molecules to be in the same stage in the cycle instead of allowing templates to follow independent cycles and, hence, shielded the true efficiency of this system. Recently, von Kiedrowski has developed¹⁵ a similar, stepwise feeding mechanism to minimise the effects of template inhibition inherent in his oligonucleotide systems. In contrast to preceding systems,

replication is directed by a template molecule immobilised on a solid support. Thus, the stable product duplexes that inhibit the release of template molecules can be specifically isolated from the reaction mixture, the duplexes cleaved from the support and then separated. The application of solid support techniques to self-replicating molecules has obvious advantages. The inhibitory effects of stable duplex formation can be effectively circumvented if the template is immobilised in this way. The feedstock could then be removed periodically and the products flushed off the solid-supported template molecules, recycling the template molecules for the next addition of feedstock.

Significant progress was also achieved by the research group of Eschenmoser, who have reported¹⁶ a template ligation of tetrameric 2',3'-cyclo-phosphates. The base sequence 4'-GCCC-2' is converted into turnover of an octamer of base sequence 4'-GCCCCCCC-2' through the addition of a template with the antiparallel sequence 4'-GGGCGGGC-2'. No turnover is observed in the absence of template, confirming the template-directed mechanism for the octamer synthesis. Although the turnover is not *via* an autocatalytic or self-replicative pathway, it is still a demonstration of efficient and controlled synthesis by a selfish catalyst.

4 The natural product approach—peptide-based systems

Ghadiri and coworkers turned to peptide-based systems¹⁷ in the quest for a successful self-replicating system. A 32 amino acid leucine zipper-type¹⁸ sequence was employed to induce molecular recognition.

The leucine zipper motif readily forms an α -helix, a tertiary structure in which a single stranded peptide forms a secondary helix with a second strand, creating a coiled coil (Fig. 6). The

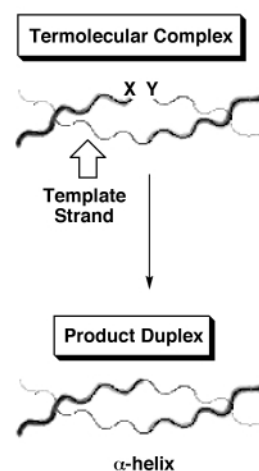

Fig. 6 The use of an α -helix as a self-replicating template, exploited by Ghadiri and Chmielewski.

template strand **T** assembles a 15- and a 17-residue fragment in an orientation that places the reactive sites in close proximity. Ligation¹⁹ between an amine nucleophile **N** and a thiobenzyl ester electrophile **E** generates a copy of the original strand. The template possesses the ability to equilibrate between two and three stranded structures, so further template-directed pathways must also be considered (Fig. 7).

The potential contribution of the reactive bimolecular routes detailed here may not be immediately obvious, but will be explained in detail later. Sigmoidal rate curves were generated without the addition of prefabricated template, but reactions were not followed to complete conversion. However, careful and systematic use of control compounds was employed to analyse the contributions of the competing template directed pathways to overall template production. The bimolecular reactions were discredited as significant contributors to autoca-

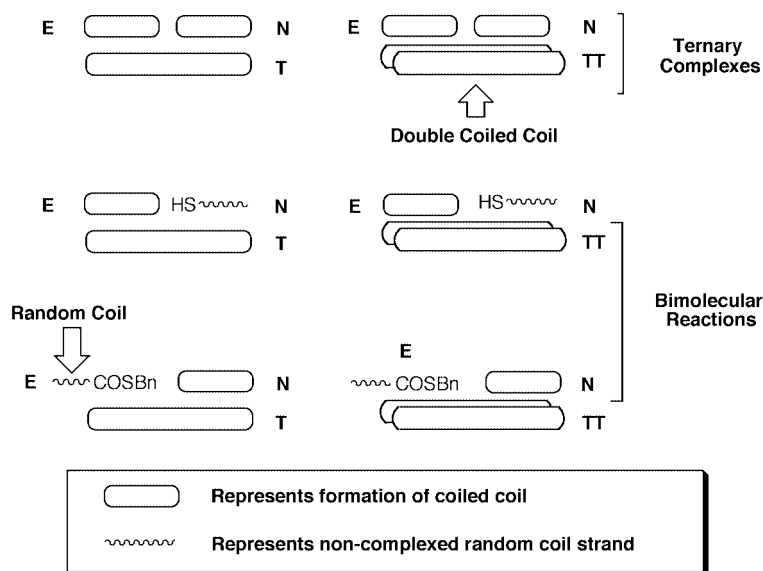

Fig. 7 The intermediates assessed as possible contributors to catalytic activity in Ghadiri's self-replicating peptide. **E** represents the electrophilic thiobenzyl ester strand and **N** represents the nucleophilic cysteine strand. **T** and **TT** represent the single and double stranded template coils respectively.

talytic turnover by generating two mutant templates **T_{9E}** and **T_{26E}**. Each mutant contained a single discrete sequence alteration in the critical binding region for either the electrophilic strand (**E_{9A}**) or the nucleophilic strand (**N_{26A}**) respectively. This created two new templates, each capable of recognizing one strand, but not the other. The recognition independent, background reaction was quantified by destroying the coiled-coil association by addition of a guanidinium salt. Therefore, control reactions had been carried out that effectively mimicked all the bimolecular pathways possible, unequivocally proving that template turnover progressed through the termolecular complexes. Despite the observation that reactions were not analysed to complete conversion, there is no premature reduction in the rate of production of template, suggesting that the recognition motif allows facile dissociation of the template duplex and return of newly fabricated template to the reaction mixture.

Ghadiri and coworkers extended²⁰ the use of their mutant building blocks **E_{9A}** and **N_{26A}** to investigate dynamic error correction in autocatalytic networks. Including the two mutant building blocks in the original reaction mixture leads to the possible production of three new template species **T_{9A}**, **T_{26A}** and **T_{9A/26A}** via a number of ternary complexes (Fig. 8).

Ghadiri and coworkers envisaged that the self-replication process would respond to the errors by utilising the mutant template species to catalyse synthesis of the native template **T**. Initially, mixtures containing equimolar quantities of (i) **E**, **N_{26A}** and **N**, or (ii) **E**, **E_{9A}** and **N** were followed, showing the

production of native template **T** (via ternary complex **5**) was favoured from these mixtures. This observation is consistent with the previously reported results utilising **N_{26A}** and **E_{9A}** as control compounds to assess the bimolecular rate of reaction. Production of **T_{9A}** or **T_{26A}**, via ternary complexes **6** or **7**, is unlikely given the destabilisation of the ternary complex caused by defects in the hydrophobic core. Experiments were then carried out establishing that **T_{9A}** and **T_{26A}** could not catalyse their own formation from mixtures of **E_{9A}**, **N** or **E**, **N_{26A}** respectively (eliminating pathways **8** and **9**). Critically, the mutant templates were then shown to catalyse the formation of native template **T** from mixtures of **E** and **N**, presumably via complexes **10** and **11**. Based on the initial rate acceleration gained, the catalytic efficiency of the mutant peptides for production of the native template was estimated at 75% of the native template itself. This observation was considered to be indicative of an error correcting network of catalytic cycles (Fig. 9).

The observation that the native template catalyses production of itself, but the mutant templates preferentially catalyse production of native template is rationalised in terms of the relative stability of the ternary complex and product duplex. The denaturing of the ternary complex (**6** or **7**) created by recognition of mutant building blocks onto **T** is sufficient to reduce turnover through this pathway. In the case of the mutant templates, it is proposed that destabilisation affects both the ternary complex (**10** or **11**) and product duplex, returning more template to the reaction mixture and enhancing the rate of

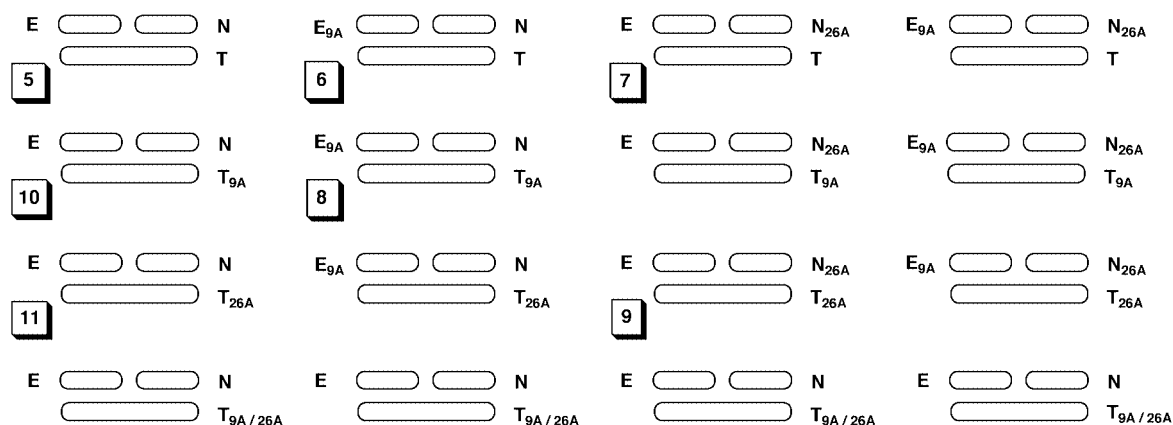

Fig. 8 Possible ternary complexes resulting in a mixture of native building blocks **E** (electrophile), **N** (nucleophile) and mutant building blocks **E_{9A}**, **N_{26A}**.

production of **T**. Considering that the product duplex that would arise from either route is identical, this is not a plausible explanation. Any differentiation between the two mechanisms must originate from subtle differences in stability of the ternary complexes.

A further self-replicating peptide has been reported²¹ by the research group of Chmielewski, which utilises the novel concept of environmental control over the reaction course. The system is based around a peptide that can only form a coiled-coil conformation under basic conditions, existing as a non-templating random coil under acidic or neutral conditions. Self-replication of the native strand from complementary building blocks is only exhibited in the presence of NaClO₄. Chmielewski exploited this preliminary work in the development²² of a cross-catalytic system that exhibits product selectivity derived from the relative stabilities of the coiled coils formed in the reaction mixture. Additional amplification was demonstrated by variation of the solution pH. However, any increase in initial rate seemed to originate from the relatively high concentrations of added templates, suggesting that product inhibition is a serious problem. This conclusion is not entirely surprising since the authors' design principles are based around the prediction of catalytic pathways that are dependent on the stability of the resulting coiled coil duplex.

5 The synthetic approach

An alternative approach to minimal self-replicating molecules was pioneered by the research group of Rebek, who developed²³ wholly synthetic molecules fulfilling the basic structural requirements of templates in a minimal self-replicating system. The essential features of Rebek's first template include adenine and imide complementary recognition sites coupled with aminolysis of an activated (pentafluorophenolate) PFP ester as the bond forming reaction. This design evolved from a system

incorporating a phenyl spacer (Fig. 10) into one containing a naphthyl spacer in the ester building block. The shorter phenyl spacer allowed the AB complex reaction pathway to dominate and quench the autocatalytic pathway.

The template design was developed to incorporate a naphthyl spacer and thus separate the reaction sites within the binary spacer complex (Fig. 11). Reaction between the two building blocks produces a self-complementary template that would be capable of assembling its own building blocks. Whilst **14** bears a passing resemblance to a nucleotide, the purpose of the ribose acetonide moiety was to provide a steric interaction that forced the templates apart in the product duplex. Consequently, the single binding interactions have an association constant of 60 M⁻¹, whilst the template dimerisation constant is only 630 M⁻¹. This observation was contrasted with the calculated 3600 M⁻¹ that would be expected for conventional summing of interactions in the absence of strong co-operative effects (although this corresponds to only a 1 kcal mol⁻¹ difference in stability).

The evidence that Rebek *et al.* provide for a self-replicating mode of action for this reaction is that addition of prefabricated template enhances the initial rate of the reaction, however, no sigmoidal curve was observed. Furthermore, the reaction of the free template **15** was ten times slower when the imide nitrogen was methylated and this is evidence that the rate enhancement was the result of molecular recognition. Despite increasing the level of design, Rebek and coworkers did not succeed in eliminating the AB complex pathway completely and ascertained that the AB complex route predominated in the production of the template. This outcome was facilitated by the formation of an unfavourable *cis* amide linkage in the bond forming step. Isomerisation to the more favourable *trans* linkage destroys the intramolecular association and produces free template **15** (Fig. 12). Rebek and coworkers estimated an association constant of 3600 M⁻² for the termolecular complex and so calculated that only 2% of the building blocks were

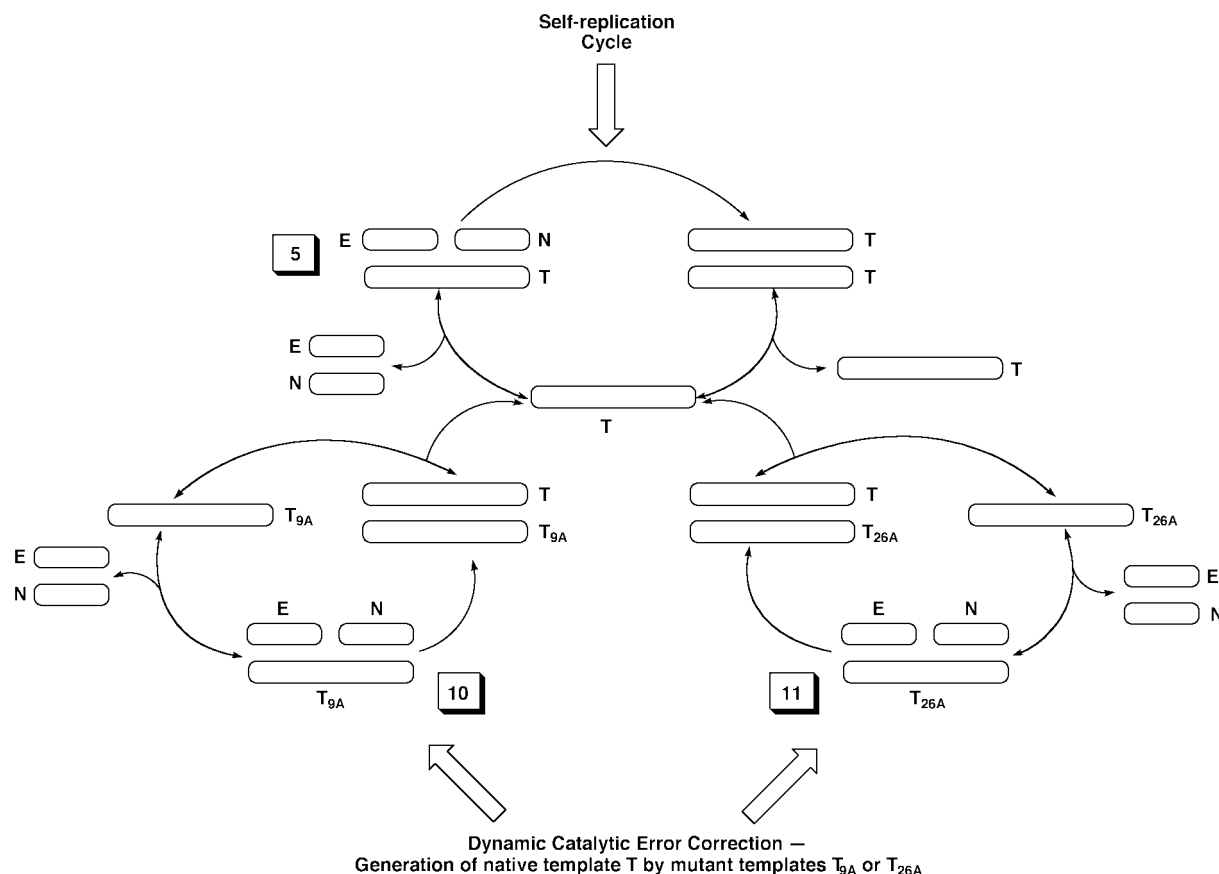

Fig. 9 Interlinking of three catalytic cycles to produce a dynamic error correcting network. **E** represents the electrophilic strand, **N** the nucleophilic strand and **T** the native template. **T_{26A}** and **T_{9A}** represent the mutant template species.

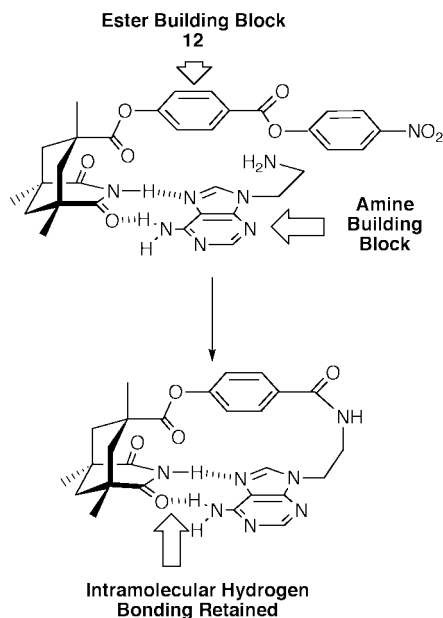

Fig. 10 Rebek's original template, incorporating a phenyl spacer in ester building block **12**, led to a reactive AB complex that remained closed via intramolecular bonding.

assembled in the termolecular complex. This suggested that the template must be a very effective catalyst to catalyse its own formation from such a small quantity of catalytic complex.

The major conclusion drawn by Rebek stated that self-replication was a significant pathway to the production of the template **15**, but the observation of a sigmoidal curve was hampered by the action of a reactive AB complex and contributions from 'systematic' errors. The principal step in producing a predominantly autocatalytic system therefore lies in preventing the formation of a reactive AB complex. The next development of this system was to lengthen one of the building blocks by replacing the naphthyl spacer with a biphenyl spacer

16 (Fig. 13). This adaptation separated the reactive centres within the AB complex and rendered it less reactive in the intramolecular sense. Indeed, this modification produced a rate curve with clear sigmoidal character.

6 Alternative kinetic interpretations

An alternative interpretation of the data presented by Rebek *et al.* for the naphthyl spacer replicating system (Fig. 11) was subsequently discussed²⁴ by Menger and coworkers, who expressed concern that the template concentration eventually diminished over a long time period. This suggested that the rate of reaction slowed down prematurely as more template was produced. This fact, coupled with the relatively small catalytic effects of Rebek's template, prompted the authors to reinvestigate the claims of autocatalytic self-replication in these systems.

Although the autocatalysis was supposed to proceed *via* the highly organised termolecular complex, the authors of this study were able to demonstrate a 25% increase in the initial rate of production of the naphthyl template **15** when the non-complementary phenyl spacer template **17** was used to seed the reaction mixture, even though the phenyl template should have been too short to assemble the naphthyl building blocks. Concluding that the catalysis did not, therefore, arise from the termolecular complex, Menger *et al.* proceeded to investigate the possibility that the catalysis arose from only part of the template. Model compounds **18** and **19** (Fig. 14) were synthesised to mimic either end of the template, but were found to have no effect on the initial rate of reaction.

In order to investigate the possibility that the amide bond of the template could be responsible for catalysis, reactions were seeded with 2-naphthoamide **20**, *N*-methylpropionamide **22** and acetamide **21**. These amides were found to increase the initial rate of reaction by 13, 31 and 40% respectively. Menger *et al.* suggested that the rate enhancement apparent in the 'self-replicating' system reported by Rebek and coworkers might

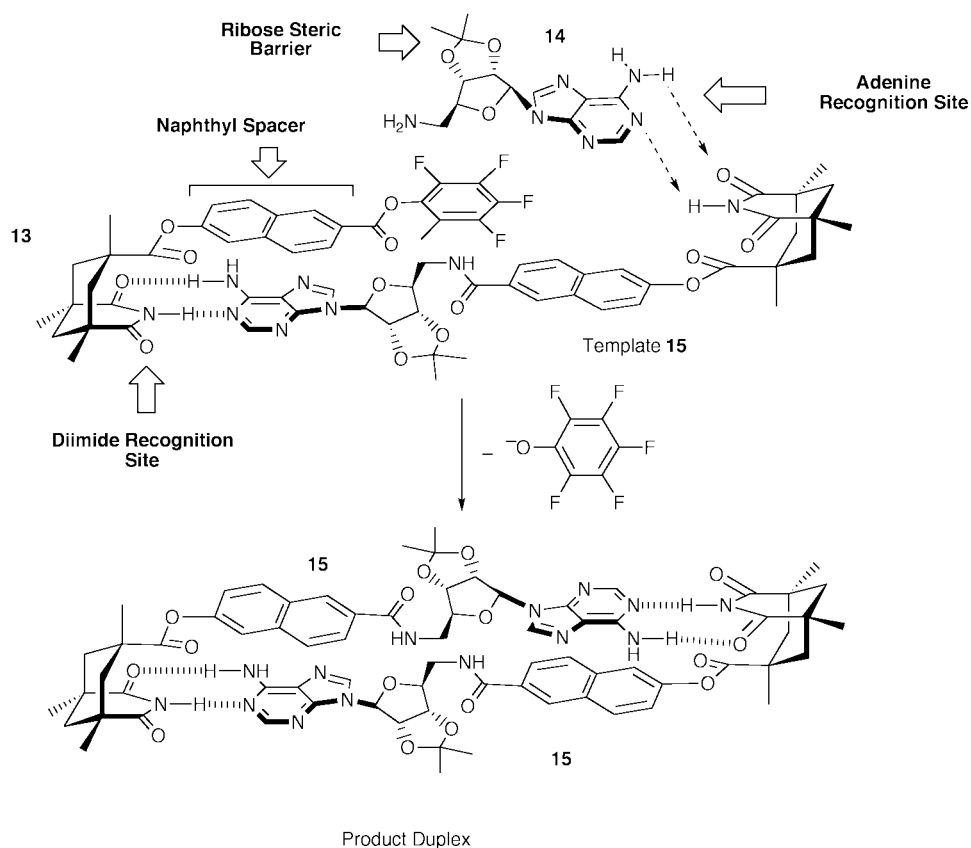

Fig. 11 Rebek's self-replicating template **15**.

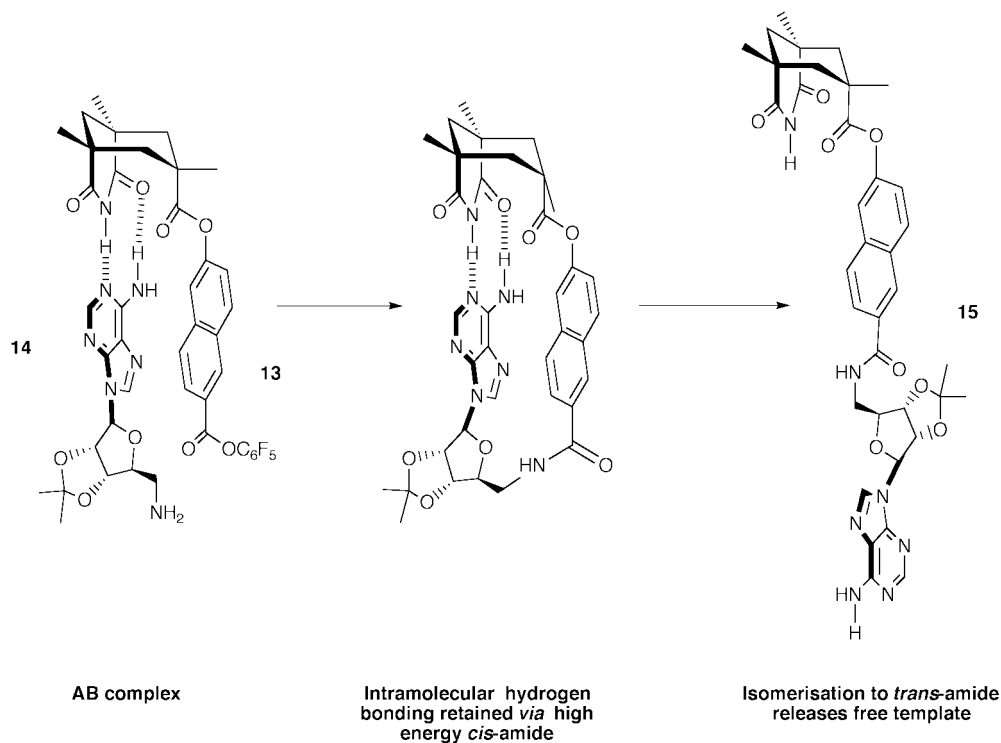

Fig. 12 Formation of template **15** via a reactive AB complex. The product does not retain intramolecular bonding and so increases the quantity of template returned to the mixture.

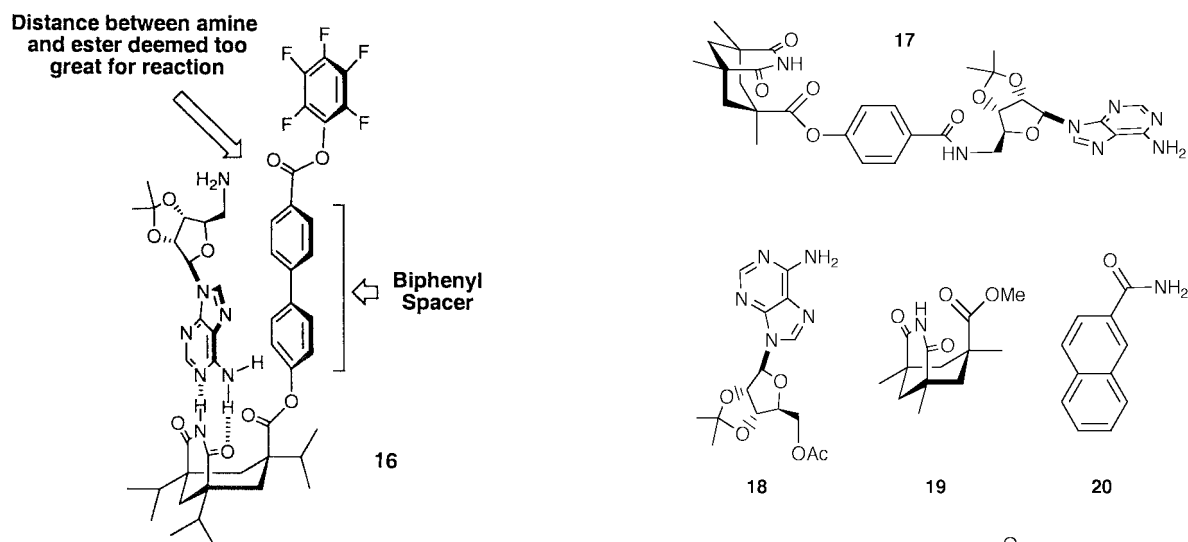

Fig. 13 Non-reactive AB complex pathway.

actually come from simple amide catalysis of the amidation reaction, bearing in mind that the product of the reaction is itself an amide. This hypothesis was tested through the use of non-binding PFP ester **23** with the Rebek amine **14** (Fig. 15). The initial rate of reaction was enhanced by seeding the reaction mixture with the template **15**, despite the inability of **23** to participate in a termolecular complex. Menger *et al.* proceeded to propose a mechanism explaining the rate enhancement found in this system, based on a bimolecular reaction between the bound amine **14** and the PFP ester **23**. This led to a tetrahedral intermediate stabilised by the amide bond of the template **15**. This mechanism directly questioned the replicative nature of Rebek's system as there was no apparent need for simultaneous recognition of both the ester and amide moieties and, therefore, the turnover could not be attributed to the ternary complex.

The validity of either mechanism representing the predominant pathway for production of **15** was addressed²⁵ by the research group of Reinhoudt and coworkers. Using an intricate and detailed kinetic pathway (Fig. 16), they were able to

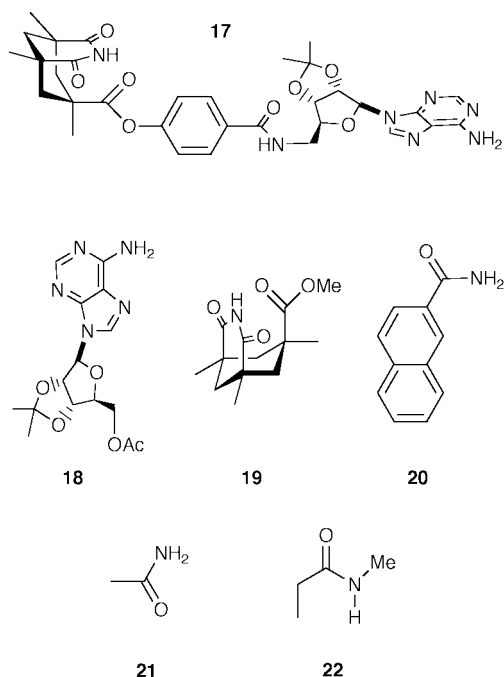

Fig. 14 The control compounds employed by Menger to investigate Rebek's self-replication system. Compound **17** is an inefficient template as it is too short to assemble the building blocks. Compounds **18** and **19** were designed to mimic either end of the original template. Compounds **20**, **21** and **22** were employed to show general amide catalysis of the bond forming step.

quantify the many different species that are a feature of a self-replicating system. The concentrations of each species were calculated using an iterative process that provided data to deduce the relative rate of each reaction path. These rates were then used to quantify the relative contributions made by the bimolecular, amide catalysed and templated pathways. Reinhoudt and coworkers concluded this paper by stating that all postulated pathways contribute in differing measures towards the total production of template, but that the reactive AB complex was the predominant reaction pathway for production of the template **15**.

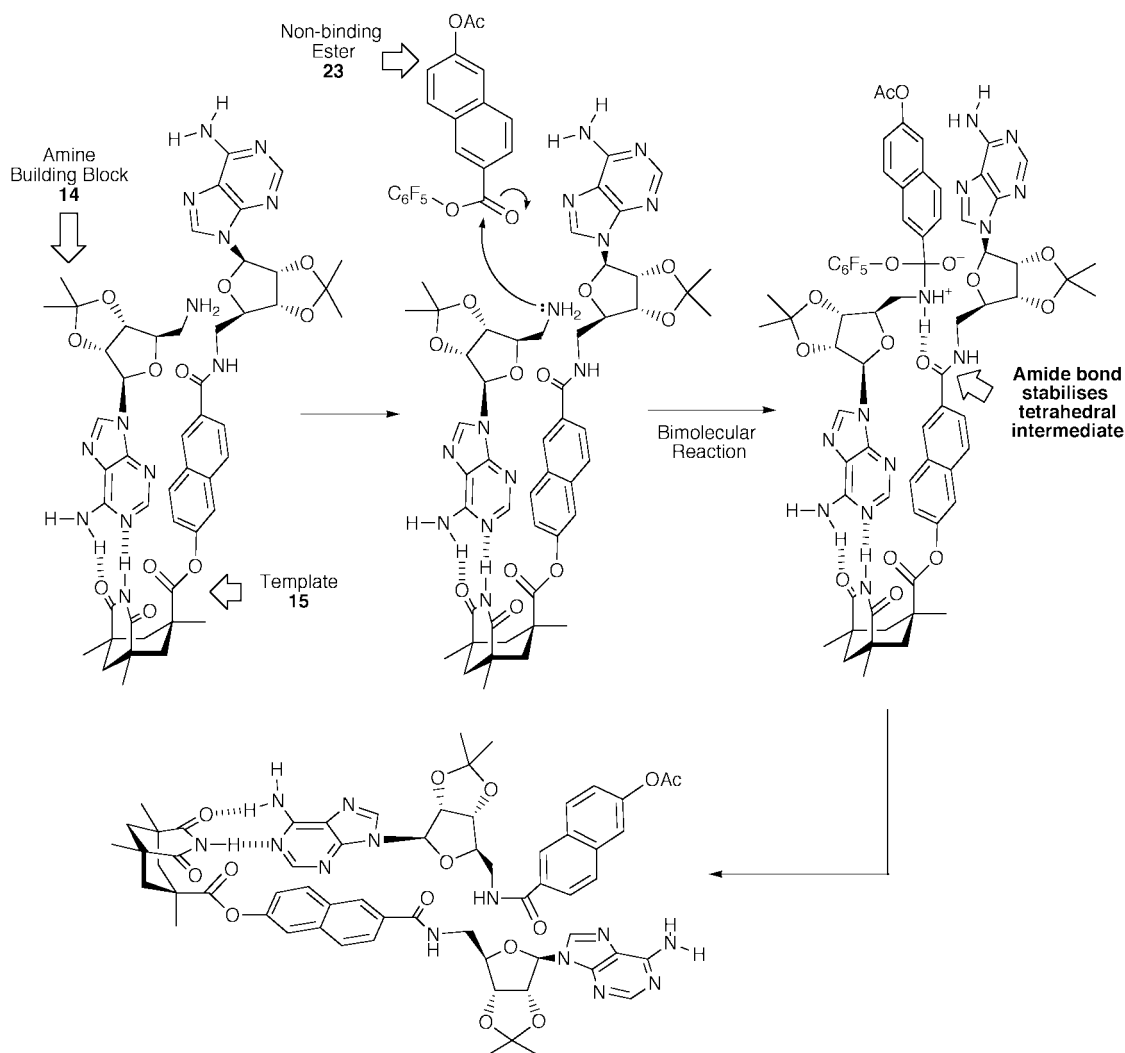
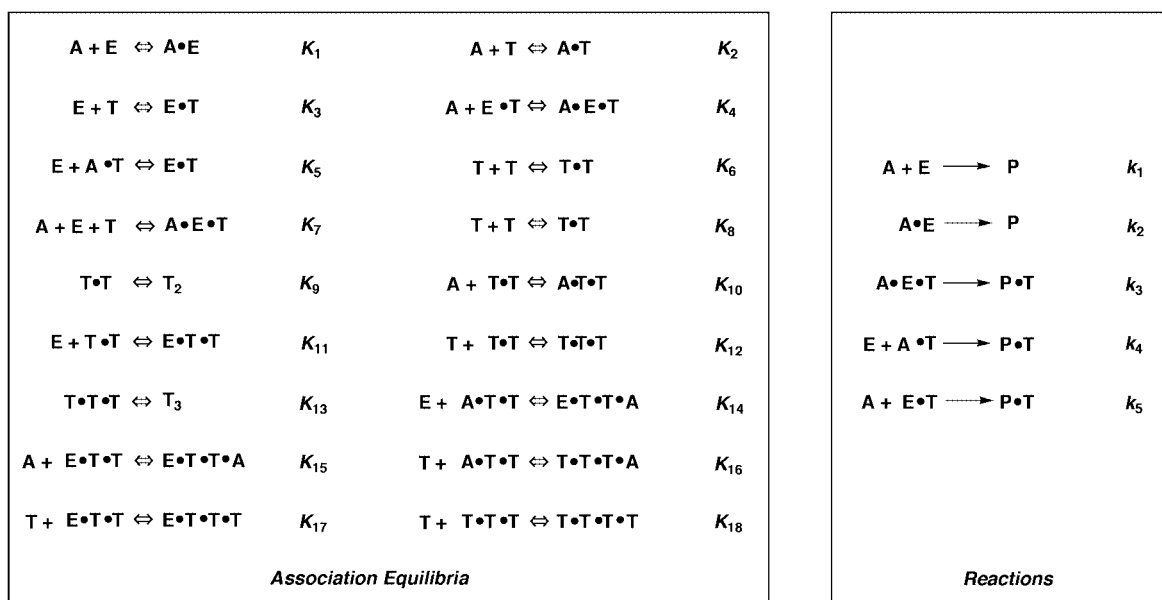

Fig. 15 Menger's proposed amide catalysis mechanism.

Fig. 16 Kinetic equilibria and reaction pathway rate constants for a minimal self-replicating system. A refers to amine, E to ester, T to template and P to template formed *via* reaction between A and B. $\cdot \cdot$ denotes a single association, T_2 and T_3 are template duplex and cyclic trimer respectively.

The research group of Rebek have since developed their initial 'replicating' system to incorporate evolutionary principles such as selection and mutation. Development²⁶ of a second template-directed system based around a xanthene scaffold, with recognition between a diaminotriazine **24** and a thymine **25**

(Fig. 17), culminated in a combination²⁷ with the earlier adenine/imide motif to produce two hybrid templates. Theoretically, both were capable of exhibiting self-replication, but only one was able to orientate the building blocks to facilitate the formation of a ternary complex. This would appear to contradict

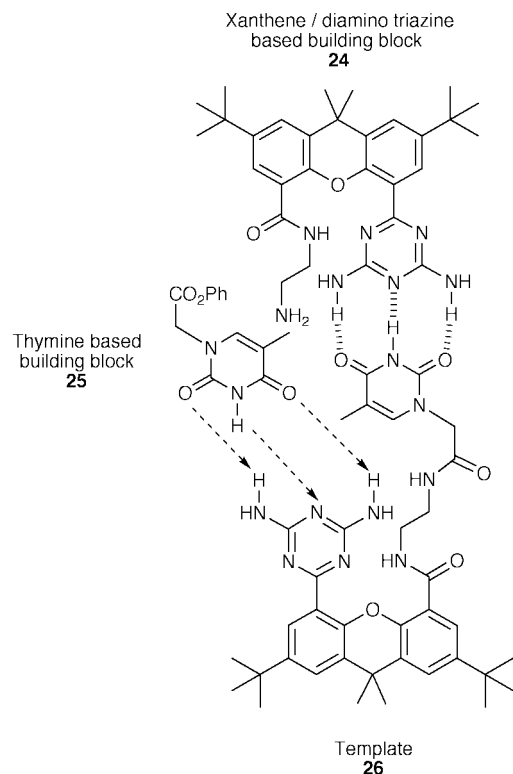

Fig. 17 A self-replicating system based on a diaminotriazine/thymine recognition motif.

a previous statement²⁵ that self-replication is ‘a simple consequence of molecular recognition’, implying a direct dependence of catalytic activity on the molecular shape of the template.

It is intended by demonstrating the progression of analysis of the above system through Rebek, Menger and, finally, Reinholdt, that the intricacy of competing pathways and their role in disrupting an autocatalytic cycle have been emphasised. These earlier studies on synthetic systems clearly identify the necessity for minimising the activity of the reactive AB complex. Abiotic systems provide the perfect tool with which to eradicate undesirable elements of a potentially self-replicating cycle, as manipulation of synthetic designs is relatively facile when compared to that of their biomimetic counterparts.

Sutherland and Wang applied²⁸ these design principles to their template-directed system based on recognition between a 2-pyridone and a naphthyridine, with a [4 + 2] Diels–Alder cycloaddition as the template forming step (Fig. 18).

The position of substitution on the pyridone provided an unproductive geometry between the reactive groups in the binary complex, removing any template turnover *via* the AB complex channel. Sutherland and Wang were immediately rewarded with the observation of a sigmoidal rate curve. However, consideration of the stereochemical implications of the bond forming reaction and the presence of a chiral building block, reveals some unexplained aspects in the analysis. The [4 + 2] cycloaddition is reported to produce an *endo* adduct, but there is no characterisation of the template **28** to support this. Self-replication of a template is further complicated by incorporation of stereogenic centres, either in the building blocks or originating as a result of the bond forming step. Consider a template-directed reaction forming a template with a single chiral centre (Fig. 19a), to which we will assign *R* stereochemistry.

This template with *R* stereochemistry can assemble with the achiral building blocks **A** and **B** to form the corresponding ternary complex. Reactions within this complex can proceed through two diastereoisomeric transition states. The energies of these transition states will differ, leading to preferential

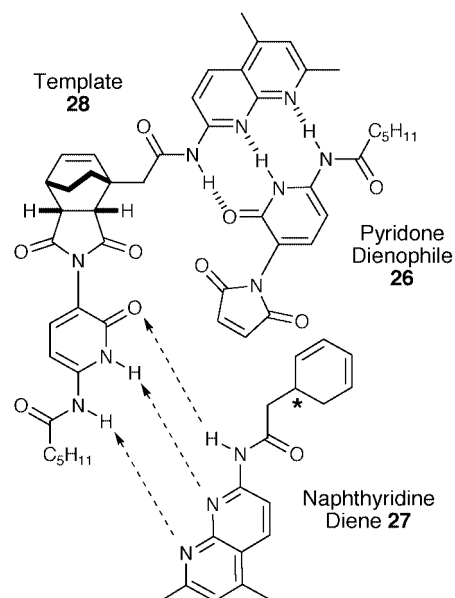

Fig. 18 A self-replicating system based on a naphthyridine/pyridone recognition motif. ‘*’ indicates a chiral centre.

selection of one of the two pathways over the other. The relative transition state energies will determine whether a racemic mixture of *R* and *S* templates is produced or a stereoselective turnover of *R* template (amplification) occurs. Now consider the situation (Fig. 19b) when one of the building blocks, **B***, also contains a chiral centre but is added as a racemic mixture to the reaction. The *R* template can now assemble the building blocks **B*** and **A** to form two diastereoisomeric complexes. Each of these complexes can proceed through two diastereoisomeric transition states leading to four possible product duplexes. The diene building block in the replicating system reported by Sutherland and Wang possesses a chiral centre and is employed as a racemic mixture. In addition, the cycloaddition forms a further four chiral centres, requiring that a much more complex version of the reaction scheme described above operates and, hence, a large number of diastereoisomeric reaction pathways must exist. No attempt is made to assign the stereochemical nature of the templates found in the reaction mixture or quantify the stereochemical effect that the recognition mediated pathway induces over the independent bimolecular reaction pathway.

7 Outlook

The ability to divide and multiply—the process of replication—is central to the survival of all living systems. The study of synthetic replicators is still in its infancy; however, in less than 15 years, the field has progressed from its origins in systems based on nucleic acids, to the design and construction of systems which are capable of performing transformations that are useful to the synthetic organic chemist in an autocatalytic and specific manner. What lies in the future for synthetic replicators? There is much still to be done in order that we might understand fully the behaviour of replicating systems. This understanding is essential if we are to exploit the ability of replicating systems to accelerate chemical reactions in a highly specific manner and to store information at a molecular level. These developments will require the assembly of libraries of synthetic replicators that will, in turn, allow the construction of meaningful structure–reactivity correlations. These relationships should permit the design of systems that are capable of exploiting the potential for information transfer, autocatalysis and amplification inherent within replicating schemes in synthetically useful applications. The understanding of replicator behaviour might then be applied to more esoteric goals

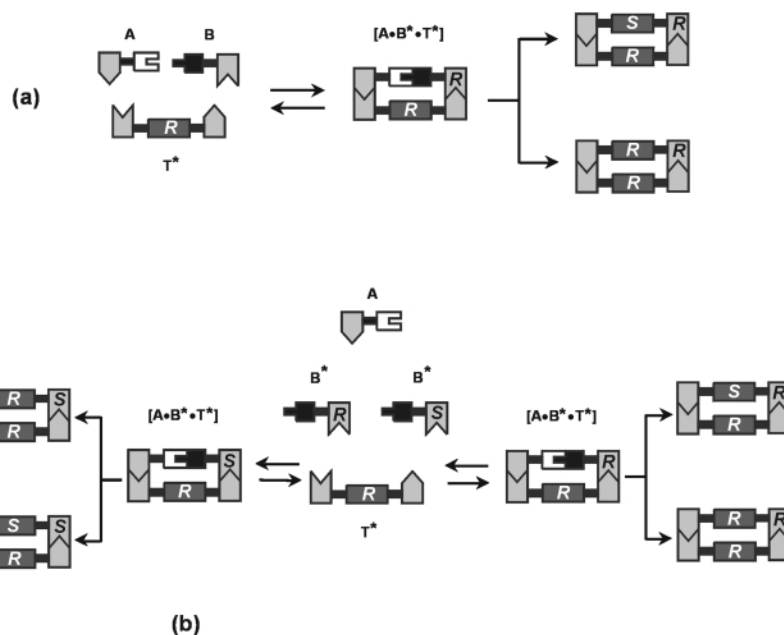

Fig. 19 (a) Template-directed synthesis forming a template T^* with a single chiral centre (assigned R stereochemistry), resulting in either amplification of the R template or a racemic mixture of R and S templates. (b) Reaction of a chiral template T^* (assigned R stereochemistry) with a racemic mixture of chiral building block B^* and achiral building block A .

such as an appreciation of the role such species may have played in the origin of life.

8 Acknowledgements

Our work on reactive AB complexes and self-replicating systems has been funded by the University of Birmingham, the Engineering and Physical Sciences Research Council and the Biotechnology and Biological Sciences Research Council. Their financial support is gratefully acknowledged.

9 References

- P. A. Sharp, *Cell*, 1985, **42**, 397; N. R. Pace, *Origins Life*, 1985, **16**, 97; L. E. Orgel, *J. Theor. Biol.*, 1986, **123**, 127.
- S. L. Miller and L. E. Orgel, *The Origins of Life on Earth*, Prentice Hall, Englewood Cliffs, NJ, 1974. An account of the simplest replicating organisms can be found in: S. Razin, *FEMS Microbiol. Lett.*, 1992, **100**, 423.
- J. von Neumann and W. Burks, *Theory of Self-Reproducing Automata*, University of Illinois Press, 1966; J. A. Reggia, S. L. Armentrout, H. H. Chou and Y. Peng, *Science*, 1993, **259**, 1282; K. J. Lee, W. D. McCormick, J. E. Pearson and H. L. Swinney, *Nature*, 1994, **369**, 215; K. J. Lee and H. L. Swinney, *Phys. Rev. E*, 1995, **51**, 1899; W. N. Reynolds, J. E. Pearson and S. Ponce-Dawson, *Phys. Rev. Lett.*, 1994, **72**, 2797; P. A. Bachmann, P. L. Luisi and J. Lang, *Nature*, 1992, **357**, 57; J. P. Ferris, *Nature*, 1995, **373**, 659; A. D. Keefe, G. L. Newton and S. L. Miller, *Nature*, 1995, **373**, 683; H. B. White, *J. Mol. Evol.*, 1976, **7**, 101; C. Tsallis and R. Ferreira, *Phys. Lett. A*, 1983, **99**, 461.
- T. Wu and L. E. Orgel, *J. Am. Chem. Soc.*, 1992, **114**, 317; L. E. Orgel, *Nature*, 1992, **358**, 203; A. Eschenmoser, *Helv. Chim. Acta*, 1996, **79**, 1249.
- P. K. Bridson and L. E. Orgel, *J. Mol. Biol.*, 1980, **144**, 567; H. Kuhn and J. Waser, *Angew. Chem., Int. Ed. Engl.*, 1981, **20**, 500; T. Inoue and L. E. Orgel, *Science (Washington DC)*, 1983, **219**, 859; T. R. Cech, *Sci. Amer.*, 1986, **255**(5), 76; G. F. Joyce, *Nature (London)*, 1989, **338**, 217; A. G. Cairns-Smith, *Genetic Takeover*, CUP, Cambridge, 1982; A. G. Cairns-Smith and H. Hartman (Eds.), *Clay Minerals and the Origin of Life*, CUP, Cambridge, 1986.
- D. Philp and J. F. Stoddart, *Angew. Chem., Int. Ed. Engl.*, 1996, **35**, 1154; J. S. Lindsey, *New J. Chem.*, 1991, **15**, 153; G. M. Whitesides, J. P. Mathias and C. T. Seto, *Science*, 1991, **254**, 1312; K. E. Drexler, *Nanosystems: Molecular Machinery, Manufacturing, and Computations*, Wiley, New York, 1992, Ch. 8.
- For some examples of efficient AB complexes see: D. Philp and A. Robertson, *Chem. Commun.*, 1998, 879; C. A. Booth and D. Philp, *Tetrahedron Lett.*, 1998, 6987; A. Robertson, D. Philp and N. Spencer, *Tetrahedron*, 1999, **55**, 11 365; R. M. Bennes, B. M. Karuki, K. D. M. Harris, D. Philp and N. Spencer, *Org. Lett.*, 1999, **1**, 1087.
- G. von Kiedrowski, *Angew. Chem., Int. Ed. Engl.*, 1986, **25**, 932.
- G. von Kiedrowski, *Bioorg. Chem. Front.*, 1993, **3**, 113.
- G. von Kiedrowski, B. Wlotzka and J. Helbing, *Angew. Chem., Int. Ed. Engl.*, 1989, **28**, 1235.
- G. von Kiedrowski, B. Wlotzka, J. Helbing, M. Matzen and S. Jordan, *Angew. Chem., Int. Ed. Engl.*, 1991, **30**, 423.
- T. Achilles and G. von Kiedrowski, *Angew. Chem., Int. Ed. Engl.*, 1989, **28**, 1235.
- D. Sievers and G. von Kiedrowski, *Chem. Eur. J.*, 1998, **4**, 629.
- T. Li and K. C. Nicolaou, *Nature*, 1994, **369**, 218.
- A. Luther, R. Brandsch and G. von Kiedrowski, *Nature*, 1998, **396**, 245.
- M. Bolli, R. Micura, S. Pitsch and A. Eschenmoser, *Helv. Chim. Acta*, 1997, **80**, 1901.
- D. H. Lee, J. R. Granja, J. A. Martinez, K. Severin and M. R. Ghadiri, *Nature*, 1996, **382**, 525.
- P. B. Harbury, T. Zhang, P. S. Kim and T. Alber, *Science*, 1993, **262**, 1401.
- P. E. Dawson, T. W. Muir, I. Clark-Lewis and S. B. H. Kent, *Science*, 1994, **266**, 776.
- D. H. Lee, J. A. Martinez, K. Severin and M. R. Ghadiri, *Chem. Eur. J.*, 1997, **3**, 1017.
- S. Yao, I. Ghosh, R. Zutshi and J. Chmielewski, *J. Am. Chem. Soc.*, 1997, **119**, 10559; S. Yao, I. Ghosh, R. Zutshi and J. Chmielewski, *Angew. Chem., Int. Ed. Engl.*, 1998, **37**, 478.
- S. Yao, I. Ghosh, R. Zutshi and J. Chmielewski, *Nature*, 1998, **396**, 447 and references therein.
- T. Tjivikua, P. Ballester and J. Rebek Jr., *J. Am. Chem. Soc.*, 1990, **112**, 1249; E. A. Wintner, M. M. Conn and J. Rebek Jr., *Acc. Chem. Res.*, 1994, **27**, 198; E. A. Wintner and J. Rebek Jr., *Acta Chem. Scand.*, 1996, **50**, 469; E. A. Wintner, M. M. Conn and J. Rebek Jr., *J. Am. Chem. Soc.*, 1994, **116**, 8877 and references therein.
- F. M. Menger, A. V. Eliseev, N. A. Khanjin and M. J. Sherrod, *J. Org. Chem.*, 1995, **60**, 2870 and references therein.
- D. N. Reinhoudt, D. M. Rudkevich and F. de Jong, *J. Am. Chem. Soc.*, 1996, **118**, 6880.
- T. K. Park, Q. Feng and J. Rebek Jr., *J. Am. Chem. Soc.*, 1992, **114**, 4529.
- Q. Feng, T. K. Park and J. Rebek Jr., *Science*, 1992, **256**, 1179.
- B. Wang and I. O. Sutherland, *Chem. Commun.*, 1997, 1495.

Review a803602k