

## ShopBot Desktop wax machining with Cut3D

### Secure Wax Block

There is now two ways to secure the block to the bed

One is with screws on MDF base

The other is with mini clamps directly on the desktop shopbot aluminum base



Glue (hot glue gun) the wax block onto a piece of osb by laying a bead of hot glue around the edges when the block is sitting flat on the osb. Screw the osb board with the wax block glued onto it to the sacrificial layer of the desktop ShopBot. Make sure not to use screws so long that they'll hit the aluminum surface below the mdf. We have less thickness to the sacrificial layers here and much less Z travel overall.

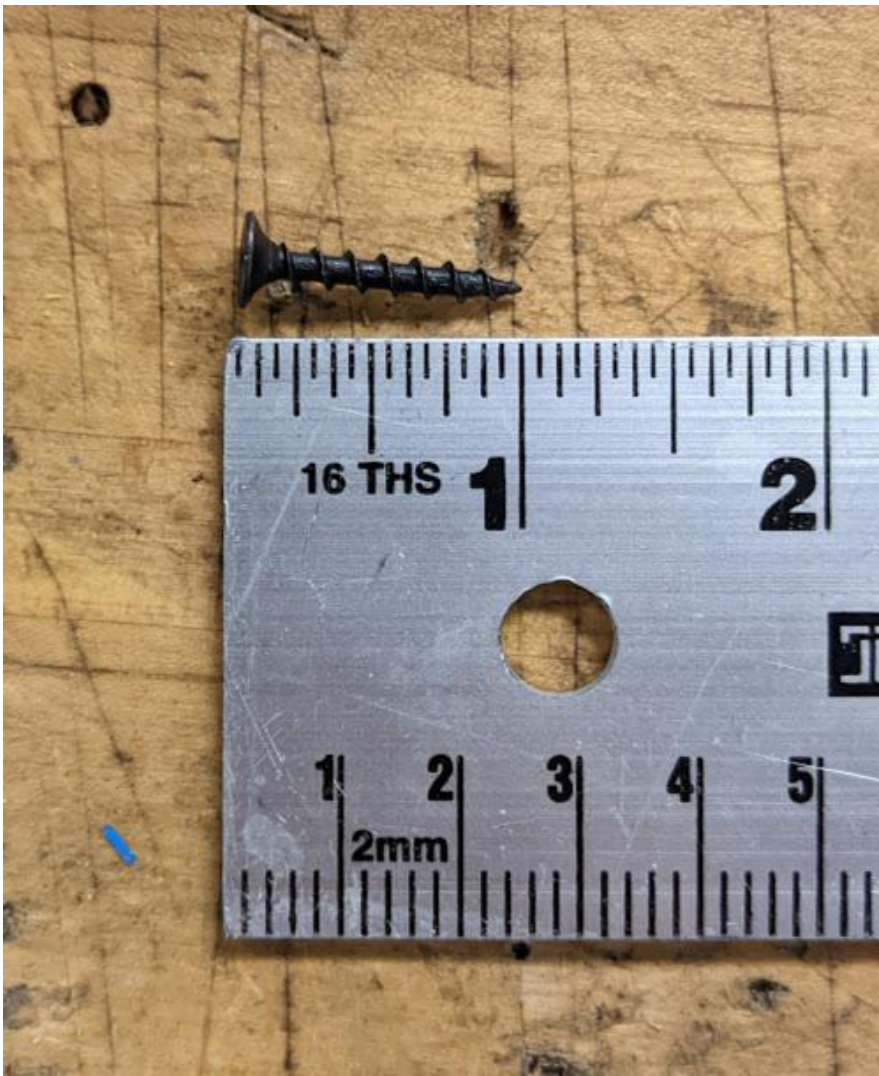

Use the shortest screws in the drawer (should be 1 inch)

Open Cut3d on the computer and load your 3d model from the file menu. One nice thing about this software is that the help menus are pretty good and if there are values attached to terminology that you aren't sure about, you can search for them in the help menus and get a better explanation about how the changes you're about to make will affect your toolpath and machining experience.

**Mini clamps directly on the desktop shopbot aluminum base**



## Setting Orientation and Size of Model

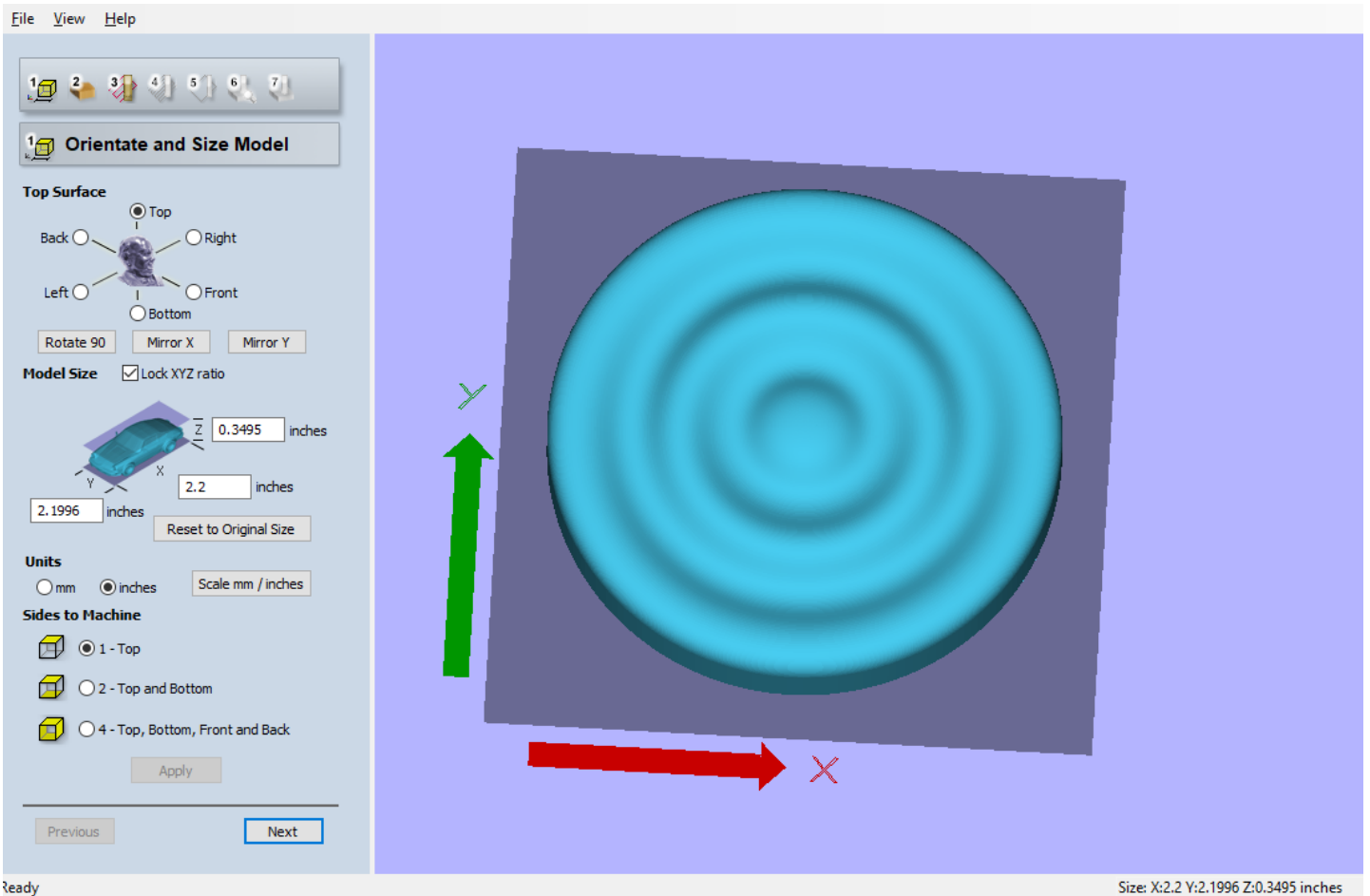

Enter in the size of your model. Be sure to leave space for machining margins that will become the walls/floor of your mold once you pour silicone into the wax.

## Setting Material Size and Margins

File View Help

1 2 3 4 5 6 7

### 2 Material Size and Margins

**Material Size**

Length (X): 3.5  
Width (Y): 3  
Thickness (Z): 1.5

Z Zero

XY Origin Position X: 0.0 Y: 0.0

**Machining Margins around Model**

Symmetrical 0.2   
 Use Model Silhouette

**Depth of Model below Surface**

0.2

**Cut Plane Position in Model**

0.3495

Ready

Circle V.2

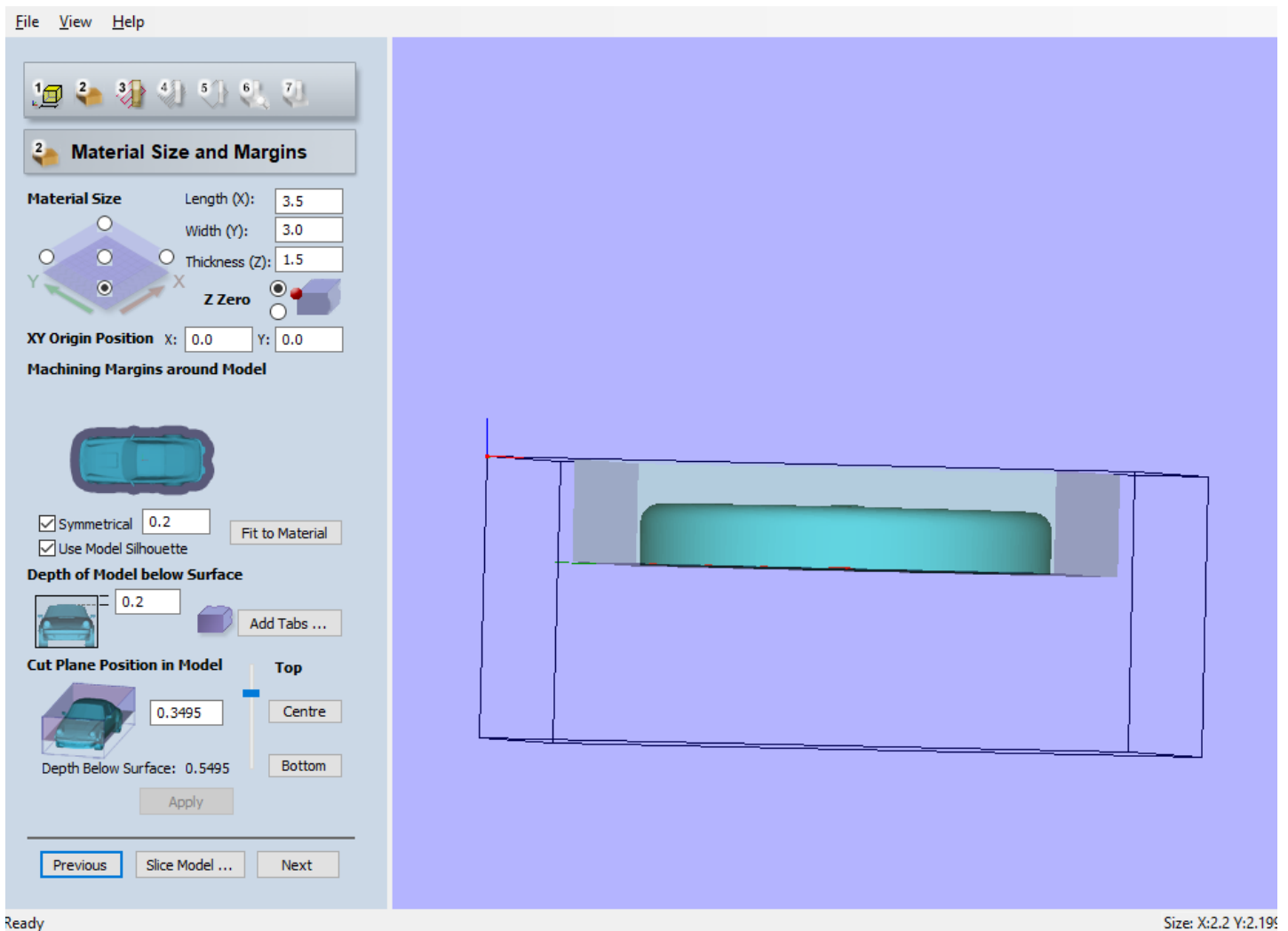

Enter in the size of your material. The toolpath will default to being in the center of whatever X and Y values you put here. The size of the wax blocks are XYZ 7" by 3" by 1.5". If you just want to use half of the block, put 3.5" for the X

In the images above, the wire frame is representing the size of your material and the shaded gray area represents the area the tool can move in. We want to have margins slightly greater than our tool diameter so we can machine down around the sides of the model which will allow us to create walls for our silicone mold. We also want to sink the model into the material on the Z a bit to allow for a floor of our silicone mold.

The **depth below surface** value at the bottom, above the apply button, is important because this shows the total depth below Z zero that the tool will go. It is very important to have **at least** as much tool sticking out of the collet as this value shows. Otherwise you will run the black collet holder into the wax block.

Click Apply, then Next

## Setting Roughing Toolpath

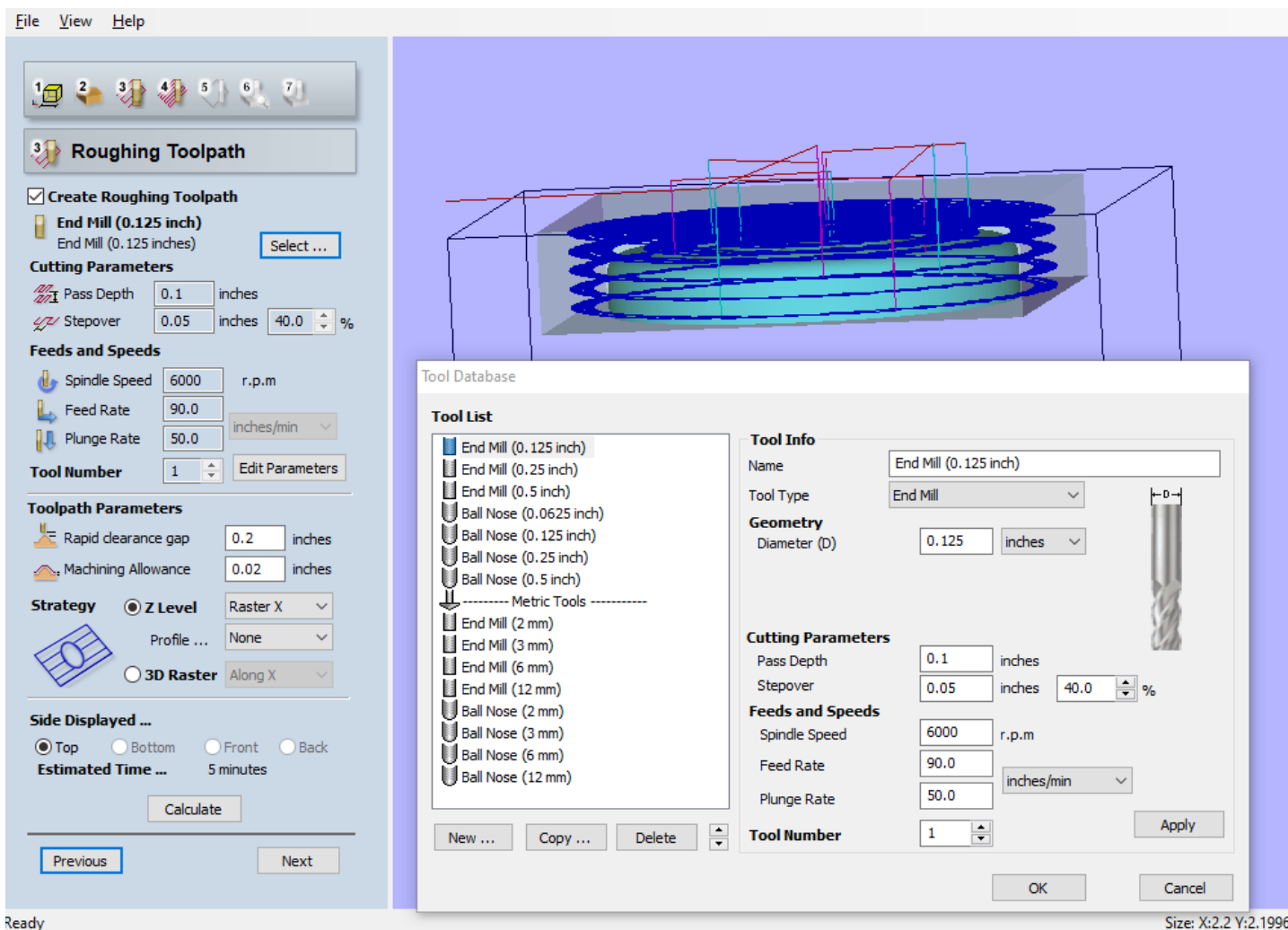

Ready

Size: X:2.2 Y:2.1996

Follow the parameters in the screenshots above for your roughing toolpath.

You can always make adjustments to your margins, generate a path and then skip to the preview to see how it has changed your result. Having margins greater than or less than the tool diameter will affect your toolpath. For some models, if there isn't sufficient margin the tool will not be able to carve all details around the perimeter of your model.

Set depth of model to .2"  
Machining allowance to .02"

Select your end mill

.125" **flat** end mill in this example. We also have the option of using a .125" **ball** end mill. Depending on your geometry there are pluses and minuses to flat vs ball end mills. Ball end mills can be better for getting into some curved valleys in your model, but will leave a sometimes undesirable radius along the wall of your silicone mold. Flat end mills won't give you that radius, but won't be able to get into the same kind of curved valleys. If you look at the very bottom of this guide you'll find pictures showing the results with both ball and flat end mills on the same model with very similar machining parameters.

Cutting parameters

Stepmover to be 40% of the tool diameter for the roughing path

Toolpath parameters: Under **strategy** select Z level, and make sure profile selection is **None**

Click Calculate to see your toolpath, then click next

## Finishing toolpath

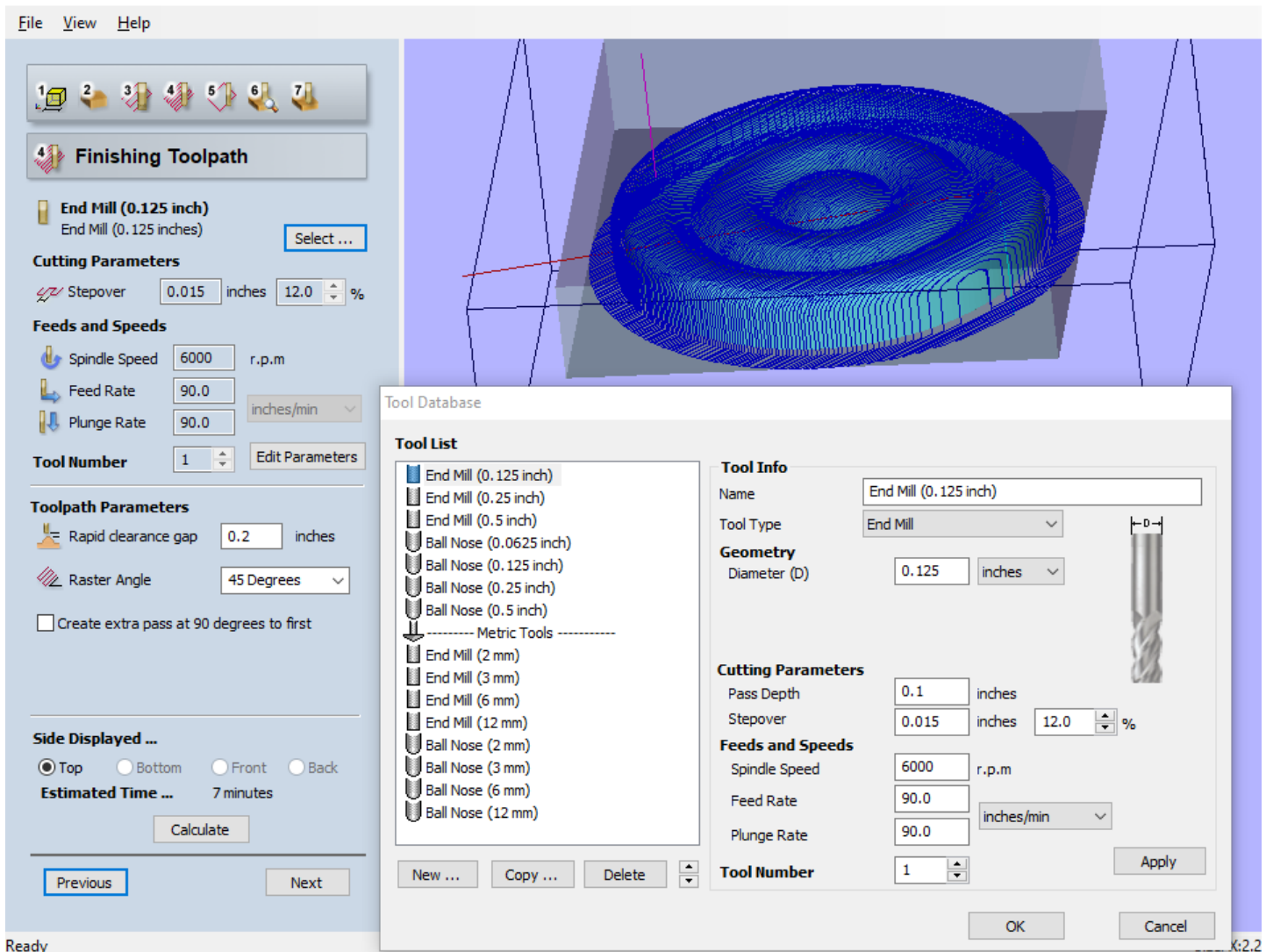

For the finishing toolpath the only significant changes we're making to our tool are that our stepover should be lowered to 10-15% of the tool diameter, and the plunge rate can be brought up to 90 to match our XY feed rates.

Under Toolpath Parameters you can add an extra pass at 90 degrees to the first if you want

Click calculate to see your finishing toolpath, then click next.

**\*\*SKIP the Cut Out Tool Path\*\***

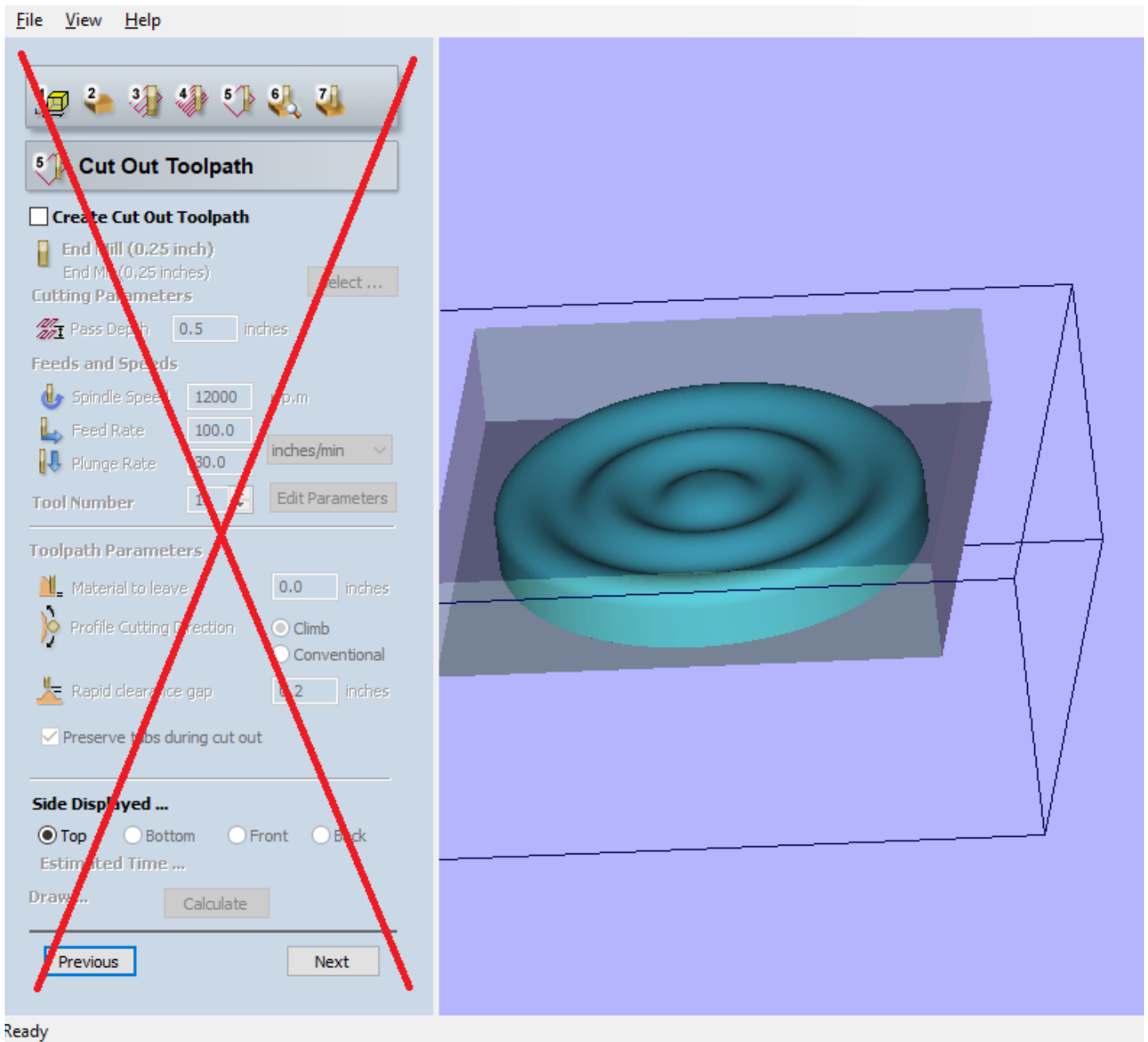

We don't want to create a cut-out toolpath for this application. Click next

### Preview toolpaths



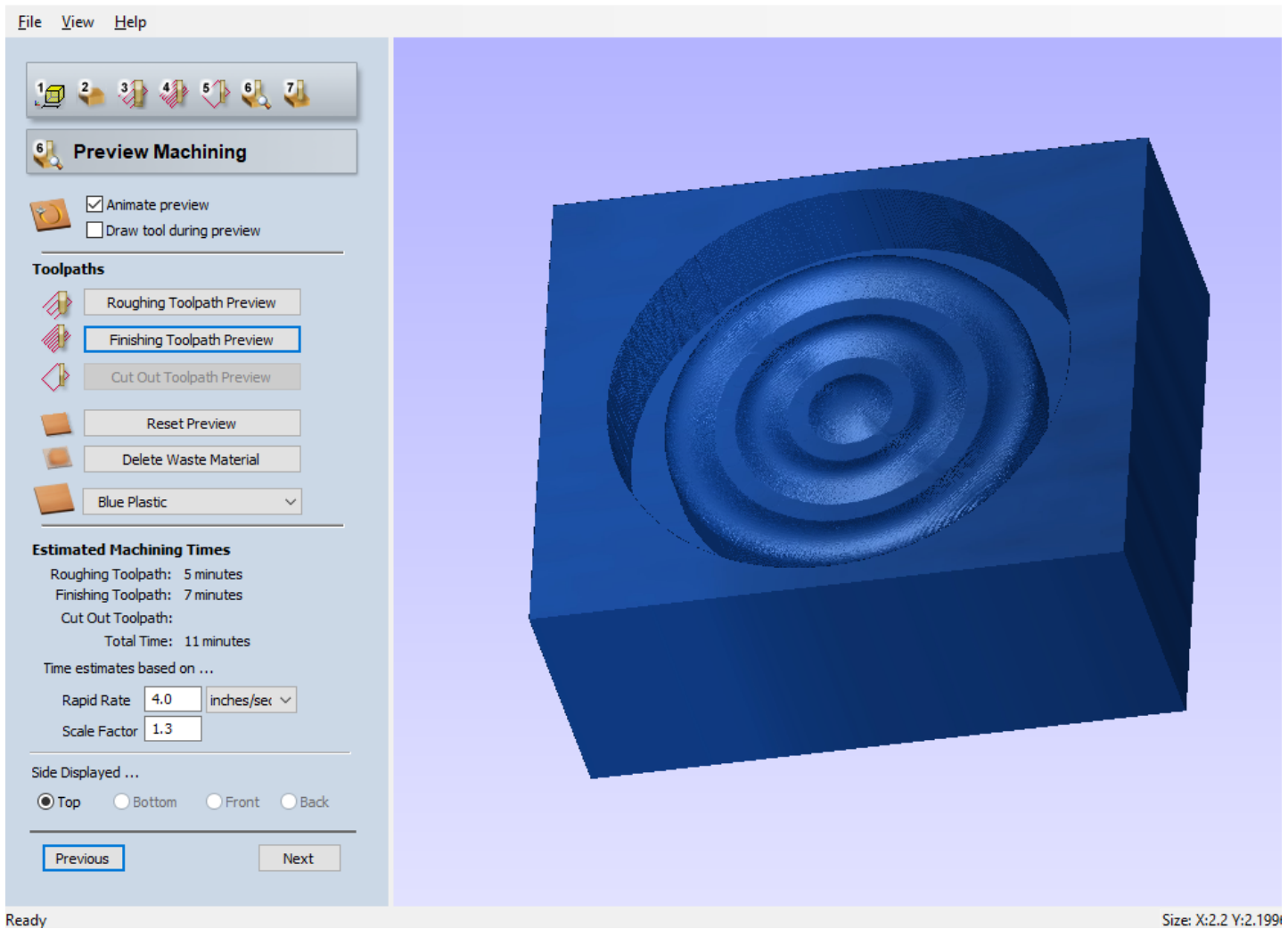

Preview Roughing, then finishing. Here you can select blue plastic from the material menu to get a more realistic idea of how your results will look in the wax you're going to machine.

Click Next

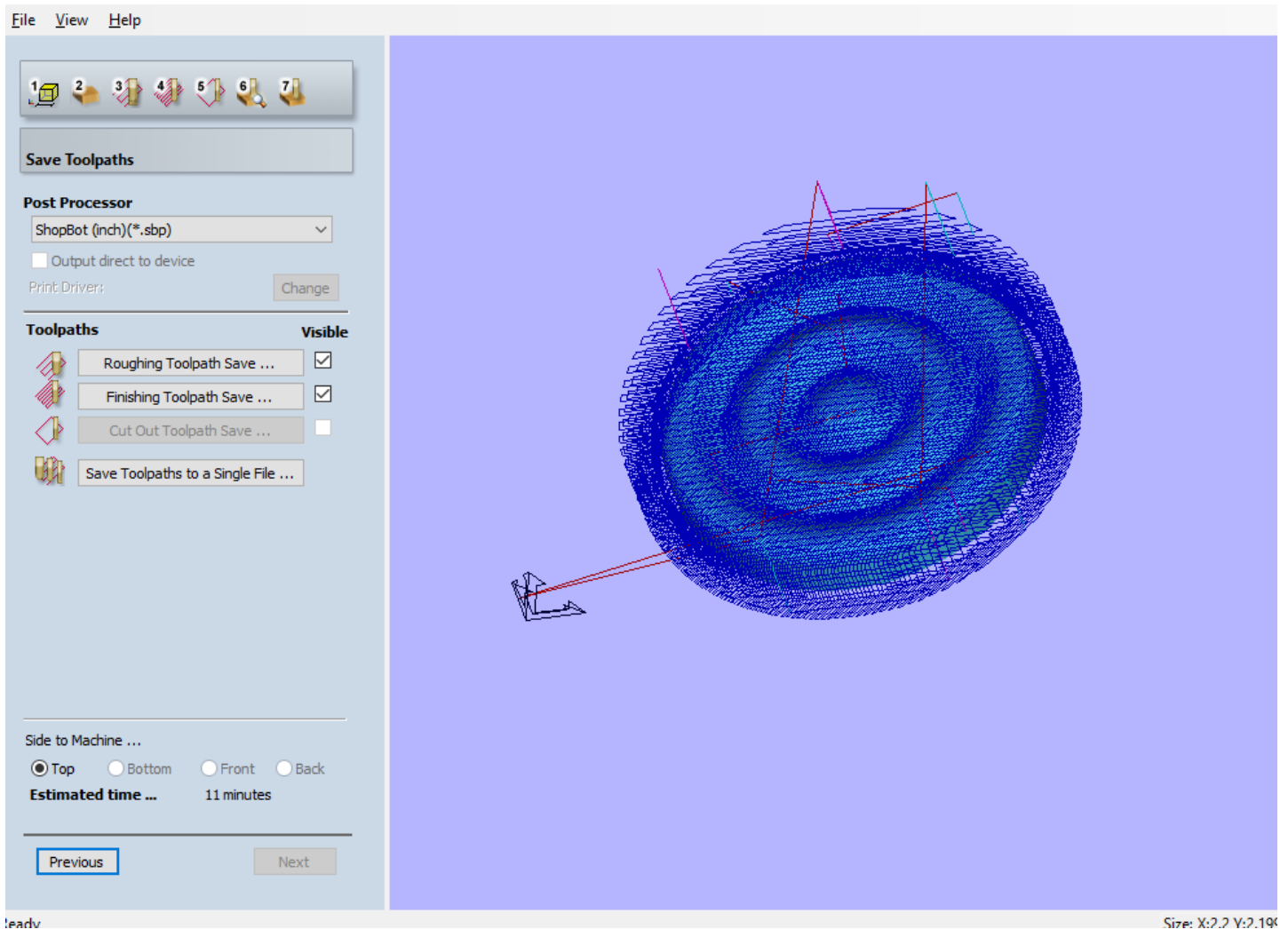

Save out roughing and finishing toolpaths. You can combine them if the program sees that you're using the same tool for both. Make sure the proper post-processor is selected from the dropdown menu (**ShopBot (inch)(.sbp)**). Even if you've used mm in the design environment, you still want to select the **inch** post-processor. You should also save your .v3d setup file from the file menu.

### Zeroing XYZ on ShopBot

Unlike the big ShopBot, the Desktop Shopbot has neither a blue nor green button that you must push for resetting the drivers and starting the spindle when prompted. The drivers will reset when the machine is turned on, and the spindle will start automatically when you run your toolpath.



The wrenches used to change the tools and collets are similar to the wrenches we used for the big ShopBot, just slightly different sized.

Command Console

[F]ile [M]ove [J]og [C]uts [Z]ero [S]ettings [V]alues [T]ools [R]ecording [U]tilities [H]elp

**ShopBot**

Speeds

Move: X & Y 2.00

Jog: 4.00

- zero [X] axis
- zero [Y] axis
- zero [Z] axis
- zero [2] axes (X and Y)**
- zero [3] axes (X, Y and Z)
- zero [T]able base coordinates

Position

X -0.000 in

Y -0.000 in

Z -0.500 in

Inputs: 1 2 3 4 5 6 7 8

Outputs: 1 2 3 4 5 6 7 8

Mode: Move/Cut (selected), Preview

Cut Part

Status: Ready - Connected [Move/Cut Mode] Elapsed: 00:00:05

Use the yellow keypad from the shopbot command console to manually jog the machine over the bottom left corner of your wax block. Then close the keypad and in the zero menu of the shopbot command console, select “Zero 2 axes (x and y)”



We will use the same z zeroing method we did on the big shopbot, with the aluminum plate positioned on top of your material and under the tool. The only difference here is that we need to attach the alligator clip to the spindle. In the cuts menu of the shopbot command console, select “C2 - zero z axis with z zeroing plate”



Setting Spindle Speed can be done with the round knob on the spindle controller. What is important to remember is that this is frequency based instead of dialing in the tool rotations per minute like on the big shopbot's spindle controller. So whatever our desired spindle speed is needs to be divided by 60, and the resulting number is what we'll dial the display to. In this case our desired RPM of 6000, divided by 60, is 100. We want the screen of the spindle controller to display 100

Once XYZ axes are zeroed and the spindle speed is set, we can run our toolpaths from the file menu of the shopbot command console.



Roughing toolpath complete

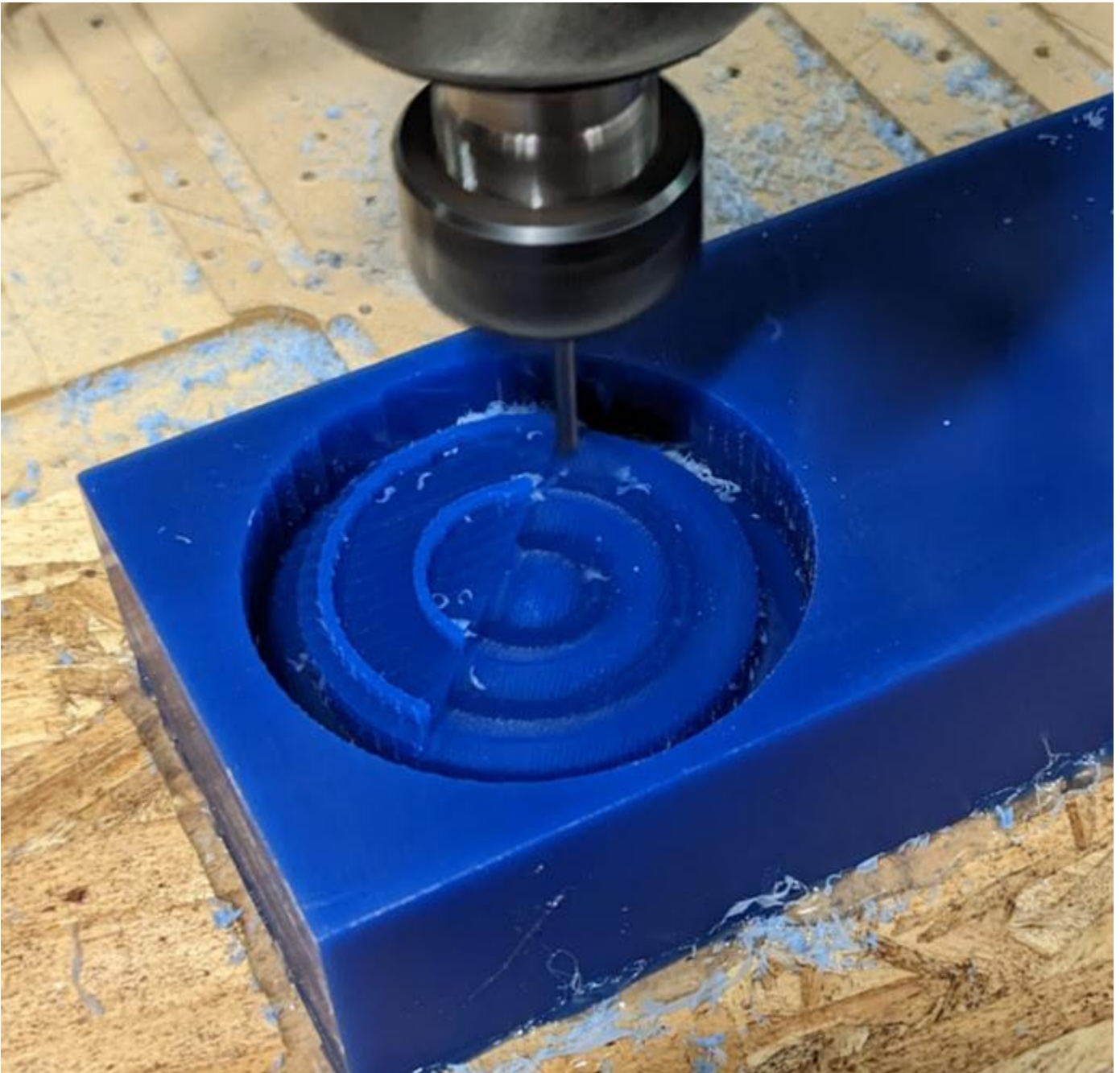

Finishing toolpath in progress



1/8" FLAT

12% FINISH STEPOVER





Finishing toolpath complete. We can see that there are margins above and around the model that will act as the walls and floor of our silicone mold once we pour silicone into this cavity. From the two images directly above, we can see that the toolpath generated for the ball end mill can get into valleys that are ignored by the toolpath using the flat end mill. Both flat and ball end mills can be good for this application, but if you're not sure which would likely be best for your particular model, the staff and TAs can help you make that determination.



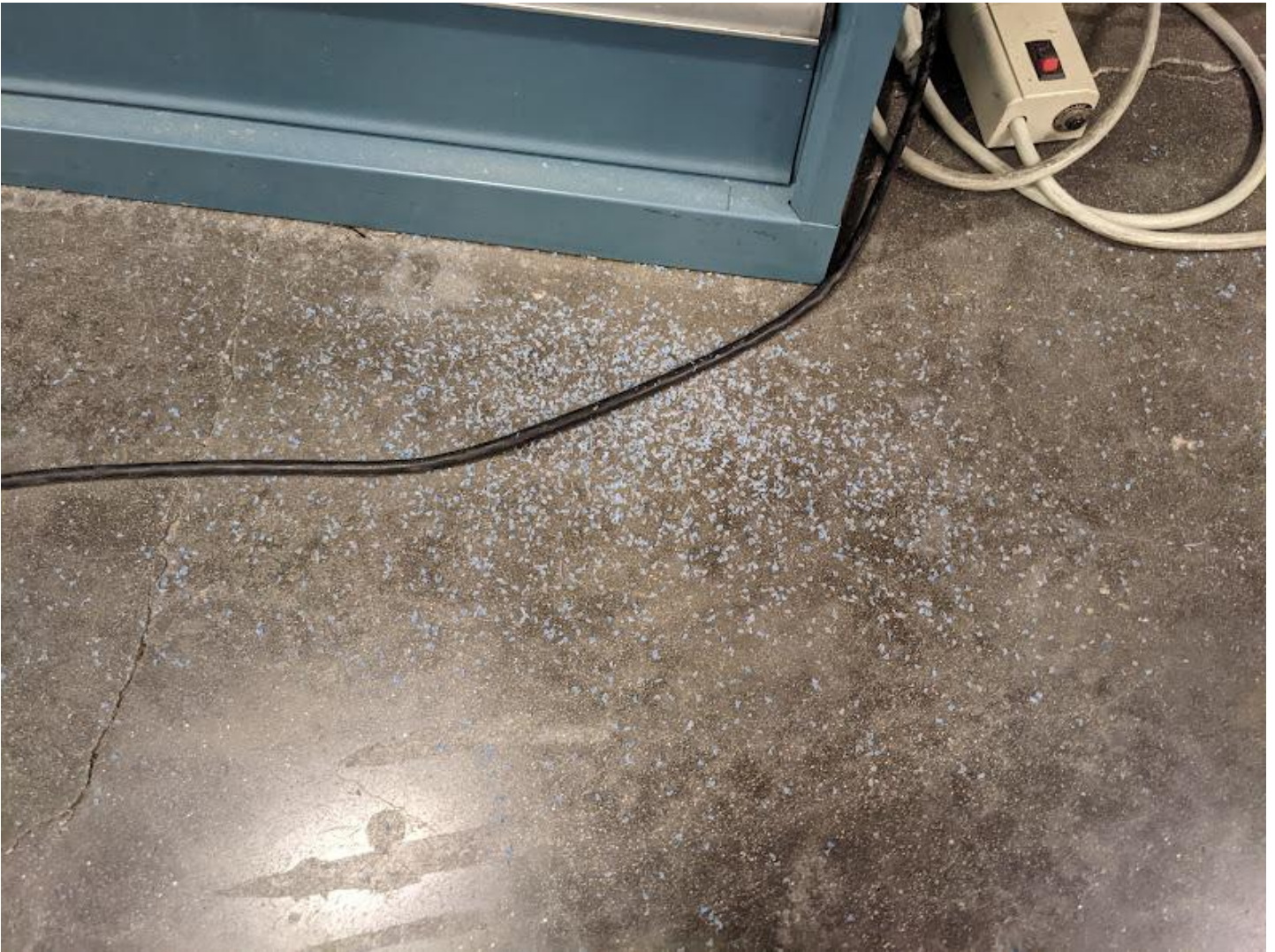

When the finishing toolpath completes, vacuum up any wax shavings from your part, the machine, and the floor around the machine. You can then use the yellow keypad to move the tool away from the part, and unscrew your osb from the sacrificial layer. Leave the machine clean and ready for the next person to get started.

If you have questions about this guide you can contact [difran@cba.mit.edu](mailto:difran@cba.mit.edu)